



crypto.com

FORMULA 1 CRYPTO.COM MIAMI GRAND PRIX



2023

MIAMI INTERNATIONAL AUTODROME | 05-07 MAY

TABLE OF CONTENTS

PART 1	GENERAL INFORMATION	
	<i>Foreword</i>	4
	<i>1.1 FIA Timetable</i>	5-8
	<i>1.2 Miami International Autodrome Map</i>	9
	<i>1.3 Miami International Autodrome - Specification/ Information</i>	10
	1.4 MIAMI TRAVEL GUIDE	
	<i>1.4.1 Greater Miami and Miami Beach Sights & Attractions - Overview</i>	11
	<i>1.4.2 Best Museums in Miami</i>	12-13
	<i>1.4.3 Parks</i>	14-15
	<i>1.4.4 History</i>	16
	<i>1.4.5 Adventure</i>	17-19
	<i>1.4.6 Beaches</i>	20
	<i>1.4.7 Restaurants & Dining Suggestions</i>	21-24
	<i>1.4.8 Shopping Suggestions</i>	25
	<i>1.4.9 Transportation/ Airport/ Taxis/ Car Rental</i>	26
	<i>1.4.10 Emergency Information/ Hospitals</i>	27
	<i>1.4.11 Additional Information</i>	28-29
PART 2	MEDIA SERVICES	
	<i>Responsibilities: Organisation & Racetrack</i>	30-31
	<i>Accreditation & Media Centre</i>	32-37
	<i>Press Conferences</i>	38
	<i>Media Transport & Shuttles, Car Park Information</i>	39-40
PART 3	2023 FIA FORMULA 1 WORLD CHAMPIONSHIP®	
	<i>3.1 Calendar</i>	41
	<i>3.2 Drivers' Entry List</i>	42
	<i>3.3 Statistical Data: Race Results, Drivers & Teams, Standing to Date</i>	43-45
	<i>3.4 Revolutionary Changes in Formula 1 in 2022</i>	46-49
	<i>3.5 Points & Classification</i>	50-51
PART 4	TEAM INFORMATION	
	<i>Mercedes AMG Petronas F1 Team</i>	52
	<i>Oracle Red Bull Racing</i>	53
	<i>McLaren F1 Team</i>	54
	<i>Scuderia Ferrari</i>	55
	<i>BWT Alpine F1 Team</i>	56
	<i>Scuderia AlphaTauri</i>	57
	<i>Aston Martin Aramco Cognizant Formula One Team</i>	58
	<i>Williams Racing</i>	59
	<i>Alfa Romeo F1 Team Orlen</i>	60
	<i>Haas F1 Team</i>	61

TABLE OF CONTENTS CONT...

PART 5	2023 Circuit Characteristics:	
	<i>Grand Prix Characteristics: Bahrain Grand Prix</i>	<i>62-63</i>
	<i>Grand Prix Characteristics: Saudi Arabian Grand Prix</i>	<i>64-65</i>
	<i>Grand Prix Characteristics: Australian Grand Prix</i>	<i>66-67</i>
	<i>Grand Prix Characteristics: Azerbaijan Grand Prix</i>	
	<i>Grand Prix Characteristics: Miami Grand Prix</i>	
	<i>Grand Prix Characteristics: Emilia Romagna Grand Prix</i>	
	<i>Grand Prix Characteristics: Monaco Grand Prix</i>	
	<i>Grand Prix Characteristics: Spanish Grand Prix</i>	<i>72</i>
	<i>Grand Prix Characteristics: Canadian Grand Prix</i>	
	<i>Grand Prix Characteristics: Austrian Grand Prix</i>	
	<i>Grand Prix Characteristics: British Grand Prix</i>	
	<i>Grand Prix Characteristics: Hungarian Grand Prix</i>	
	<i>Grand Prix Characteristics: Belgium Grand Prix</i>	
	<i>Grand Prix Characteristics: Dutch Grand Prix</i>	
	<i>Grand Prix Characteristics: Italian Grand Prix</i>	
	<i>Grand Prix Characteristics: Singapore Grand Prix</i>	
	<i>Grand Prix Characteristics: Japanese Grand Prix</i>	<i>84</i>
	<i>Grand Prix Characteristics: Qatar Grand Prix</i>	
	<i>Grand Prix Characteristics: United States Grand Prix</i>	<i>85</i>
	<i>Grand Prix Characteristics: Mexico City Grand Prix</i>	<i>86</i>
	<i>Grand Prix Characteristics: Brazilian Grand Prix</i>	<i>87</i>
	<i>Grand Prix Characteristics: Las Vegas Grand Prix</i>	
	<i>Grand Prix Characteristics: Abu Dhabi Grand Prix</i>	<i>88</i>
PART 6	SUPPORT RACES	
	<i>6.2 Porsche Sprint Challenge North America</i>	<i>92-93</i>

Dear members of the media,

Welcome to the Miami International Autodrome and the FORMULA 1 CRYPTO.COM MIAMI GRAND PRIX 2023. On behalf of the whole team at South Florida Motorsports (SFM), we hope that you enjoy your visit to the city of Miami and are as excited as we are for the on-track action to begin.

This weekend marks the first of three Formula 1 races to be held in the United States this year, highlighting the incredible popularity of the sport here at the present time.

Twelve months ago, we hosted our first-ever Formula 1 Grand Prix and it was an unforgettable occasion. From the Wednesday night Opening Party on the podium at Hard Rock Stadium, to the action-packed 57 laps on race day, the whole weekend gave us a chance to showcase the vibrancy and culture of Miami to the world.

Since our inaugural race, we have worked tirelessly to make this 2023 event even better in our pursuit to deliver a best-in-class experience for all - drivers, teams, fans and media alike.

We have invested significantly in all areas, including a full track repave and the construction of a brand-new permanent Paddock Club structure – complete with rooftop terrace. In addition, we have added new luxury spaces throughout the Campus, increased grandstand capacity to 56,000 and updated the Campus Pass, adding elevated trackside viewing platforms to give more fans the opportunity to enjoy the incredible spectacle of the FORMULA 1 CRYPTO.COM MIAMI GRAND PRIX 2023.

Working with over 65 of the best restaurants in South Florida, we have also expanded and enhanced many of our marquee features around the Campus to welcome back guests to sample our premium offerings, including the Yacht Club, MIA Marina and Hard Rock Beach Club.

We have also made changes to the Formula 1 paddock, moving the teams' hospitality units to the football field of Hard Rock Stadium to create an all-new Team Village – which all ticket holders can now experience from above from the 300 level. The remaining areas of the paddock have also been reimaged to incorporate the culture of Miami through art, design as well as food and beverage offerings, which we hope you take time to enjoy amongst the busy working days.

At the heart of our event is the local community and our economic impact report's findings revealed that last year's race boosted the local economy to the tune of \$350 million. We continue to work closely with the residents of Miami Gardens, in both educational programs, internships and employment to positively engage the local community.

In everything we do, we are committed to providing an unparalleled experience for everyone who attends the Miami International Autodrome for this year's race. Thank you for your attendance and enjoy the weekend.

Tyler Epp
President
FORMULA 1 CRYPTO.COM MIAMI GRAND PRIX 2023

1. GENERAL INFORMATION

1.1 TIMETABLE - FORMULA 1® CRYPTO.COM MIAMI GRAND PRIX 2023

THURSDAY -		06:41	SUNRISE	
		09:00	TEAM CURFEW ENDS (STARTED WEDNESDAY 20:30)	
09:00	11:45	FIA	TRACK	TRACK OPEN TO F1 PASS HOLDERS
11:00	12:00	FORMULA 1	TRACK	FILMING ACTIVITY
12:00	15:00	FIA	TRACK	TRACK CLOSED, FIA/F1 SYSTEMS CHECKS. TRACK RESTRICTED TO FIA/F1 ONLY
13:30	14:00	PROMOTER ACTIVITY	ONLINE MEETING	SECURITY BRIEFING
13:45	14:00	FIA	TRACK	TRACK INSPECTION
14:00	15:00	FIA	TRACK	HIGH SPEED TRACK TEST
15:00	16:00	FORMULA 1	TRACK	FORMULA 1 PIRELLI HOT LAPS
15:00	16:05	FORMULA 1	PRESS CONF. ROOM	F1 DRIVER & MEDIA ACTIVITY
16:40	TRACK OPEN TO F1 PASS HOLDERS			
16:00	16:20	PROMOTER ACTIVITY	TRACK	SAFETY TEAMS TRACK FAMILIARIZATION
16:15	17:00	PROMOTER ACTIVITY	TRACK	COMMUNITY PIT LANE WALK
17:00	18:00	F1 EXPERIENCES	PIT LANE	F1 EXPERIENCES PIT LANE WALK
18:00	20:00	F1 EXPERIENCES	TRACK	F1 EXPERIENCES LIVE
19:53	SUNSET			
20:00	TEAM CURFEW STARTS			

* These times refer to the start of the formation lap¹ Fixed End Session² Approximate Finishing time
PLEASE NOTE THAT THIS TIMETABLE IS SUBJECT TO AMENDMENTS



1. GENERAL INFORMATION

1.1 TIMETABLE - FORMULA 1® CRYPTO.COM MIAMI GRAND PRIX 2023

FRIDAY -		06:41	SUNRISE	
10:00		TEAM CURFEW ENDS		
11:00	11:30	PROMOTER ACTIVITY	TRACK	MEDIA TOUR
11:00	12:00	FORMULA 1	PRESS CONF. ROOM	TEAM MANAGERS' MEETING
12:00	12:35	PADDOCK CLUB	TRACK	PADDOCK CLUB TRACK TOUR
12:00	13:30	PADDOCK CLUB	PIT LANE	PADDOCK CLUB PIT LANE WALK
12:30	13:30	FIA	PIT LANE	F1 CAR PRESENTATION
12:40	13:25	FORMULA 1	TRACK	FORMULA 1 PIRELLI HOT LAPS
13:25	13:35	FIA	TRACK	TRACK INSPECTION & F1
				STEWARDS' FAMILIARISATION
13:35	13:50	FIA	TRACK	TRACK INSPECTION & SAFETY
				CAR TEST
14:00	15:00¹	FORMULA 1	TRACK	FIRST PRACTICE SESSION
15:30	16:00 ¹	PORSCHE CARRERA CUP NA	TRACK	FIRST PRACTICE SESSION
15:30	16:30	FORMULA 1	PRESS CONF. ROOM	TEAM PRESS CONFERENCE
16:10	16:35	FORMULA 1	TRACK	FORMULA 1 PIRELLI HOT LAPS
16:10	17:05	PADDOCK CLUB	PIT LANE	PADDOCK CLUB PIT LANE WALK
16:35	17:05	PADDOCK CLUB	TRACK	PADDOCK CLUB TRACK TOURS
17:05	17:15	FIA	TRACK	TRACK INSPECTION
17:30	18:30¹	FORMULA 1	TRACK	SECOND PRACTICE SESSION
19:00	19:30 ¹	PORSCHE CARRERA CUP NA	TRACK	SECOND PRACTICE SESSION
19:35	20:20	FIA	PIT LANE	MARSHAL'S PIT LANE WALK
19:40	20:00	PADDOCK CLUB	TRACK	PADDOCK CLUB TRACK TOURS
19:50			TRACK OPEN TO F1 PASS HOLDERS	
19:54			SUNSET	
20:00	21:00	FIA	DRIVERS BRIEFING ROOM	F1 DRIVERS' MEETING
22:30		TEAM CURFEW STARTS		

* These times refer to the start of the formation lap¹ Fixed End Session² Approximate Finishing time
PLEASE NOTE THAT THIS TIMETABLE IS SUBJECT TO AMENDMENTS



1. GENERAL INFORMATION

1.1 TIMETABLE - FORMULA 1® CRYPTO.COM MIAMI GRAND PRIX 2023

SATURDAY		06:40	SUNRISE	
09:30			TEAM CURFEW ENDS	
09:30	09:40	FIA	TRACK	MEDICAL INSPECTION
09:40	09:55	FIA	TRACK	TRACK INSPECTION & SAFETY CAR TEST
10:15	10:45	PORSCHE CARRERA CUP NA	TRACK	QUALIFYING SESSION
10:55	11:25	PROMOTER ACTIVITY	TRACK	FERRARI PARADE (HIGH SPEED)
10:55	11:25	FORMULA 1	PIT LANE	PIT STOP PRACTICE
11:00	12:00	PADDOCK CLUB	PIT LANE	PADDOCK CLUB PIT LANE WALK
11:30	12:00	FORMULA 1	TRACK	FORMULA 1 PIRELLI HOT LAPS
12:05	12:15	FIA	TRACK	TRACK INSPECTION
12:30	13:30¹	FORMULA 1	TRACK	THIRD PRACTICE SESSION
14:00	14:05	PORSCHE CARRERA CUP NA	TRACK	GRID PROCEDURE
14:05*	14:50²	PORSCHE CARRERA CUP NA	TRACK	FIRST RACE (40 MINS + 1 LAP)
15:00	15:40	PADDOCK CLUB	PIT LANE	PADDOCK CLUB PIT LANE WALK
15:00	15:40	PADDOCK CLUB	TRACK	PADDOCK CLUB TRUCK TOUR
15:40	15:50	FIA	TRACK	TRACK INSPECTION
16:00	17:00	FORMULA 1	TRACK	QUALIFYING SESSION
17:00	18:00	FORMULA 1	PRESS CONF. ROOM	PRESS CONFERENCE
17:15	18:15	PADDOCK CLUB	TRACK	PADDOCK CLUB TRUCK TOUR
17:15	18:15	F1 EXPERIENCES	TRACK	F1 EXPERIENCES CHAMPIONS CLUB GRID WALK & TROPHY PHOTO
17:20	TRACK OPEN TO F1 PASS HOLDERS			
18:15	19:00	PROMOTER ACTIVITY	TRACK	72 CLUB TRACK TOUR
19:55	SUNSET			

* These times refer to the start of the formation lap ¹ Fixed End Session ² Approximate Finishing time
PLEASE NOTE THAT THIS TIMETABLE IS SUBJECT TO AMENDMENTS



1. GENERAL INFORMATION

1.1 TIMETABLE - FORMULA 1® CRYPTO.COM MIAMI GRAND PRIX 2023

SUNDAY		06:39	SUNRISE	
10:15	10:25	FIA	TRACK	MEDICAL INSPECTION
10:25	10:40	FIA	TRACK	TRACK INSPECTION & SAFETY CAR TEST
10:30		F1 CAR COVER SEALS REMOVED		
10:45	11:15	PADDOCK CLUB	TRACK	PADDOCK CLUB TRACK TOURS
10:45	11:50	PADDOCK CLUB	PIT LANE	PADDOCK CLUB PIT LANE WALK
11:15	12:00	FORMULA 1	TRACK	FORMULA 1 PIRELLI HOT LAP
12:10	12:15	PORSCHE CARRERA CUP NA	TRACK	GRID PROCEDURE
14:05*	14:50²	PORSCHE CARRERA CUP NA	TRACK	SECOND RACE (40 MINS + 1 LAP)
13:15	13:45	PADDOCK CLUB	TRACK	PADDOCK CLUB TRUCK TOUR
13:15	14:15	PADDOCK CLUB	PIT LANE	PADDOCK CLUB PIT LANE WALK
13:20	13:50	FORMULA 1	TRACK	DRIVERS' PARADE
13:50	14:20	PROMOTER ACTIVITY	TRACK	GRID PRESENTATION
14:00	14:10	PROMOTER ACTIVITY	AIR DISPLAY	LEAP FROGS PARACUTE TEAM
14:10	14:20	PROMOTER ACTIVITY	AIR DISPLAY	RED BULL SKY DIVERS
14:20	14:30	FIA	TRACK	TRACK & MEDICAL INSPECTION
14:40	14:50	FORMULA 1	PIT LANE	PIT LANE OPEN
15:08	15:18	FORMULA 1	TRACK	DRIVER INTRODUCTION & NATIONAL ANTHEM
15:30*	17:30²	FORMULA 1	TRACK	GRAND PRIX (57 LAPS OR 120 MINS)
17:30	18:30	FORMULA 1	PRESS CONF. ROOM	POST RACE TOP 3 FINISHERS PRESS CONFERENCE
19:55		SUNSET		

* These times refer to the start of the formation lap ¹ Fixed End Session ² Approximate Finishing time
PLEASE NOTE THAT THIS TIMETABLE IS SUBJECT TO AMENDMENTS



1. GENERAL INFORMATION

1.2 MIAMI INTERNATIONAL AUTODROME - CIRCUIT MAP OVERVIEW

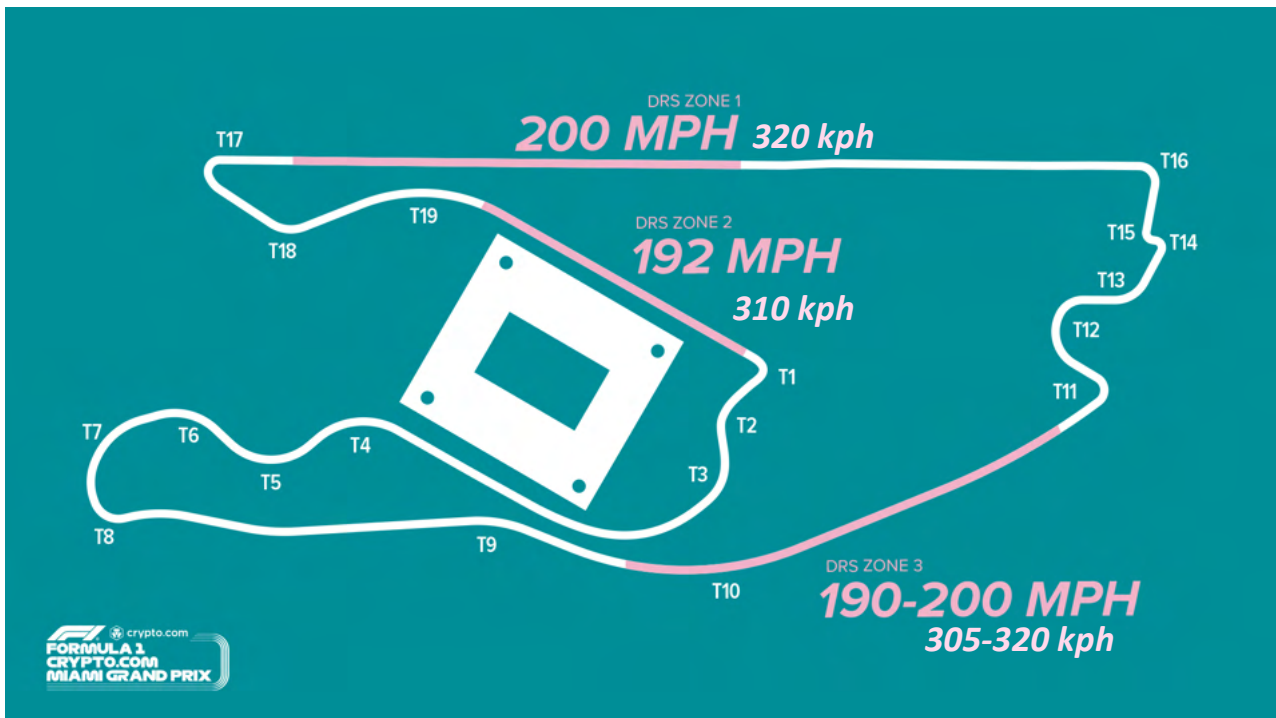
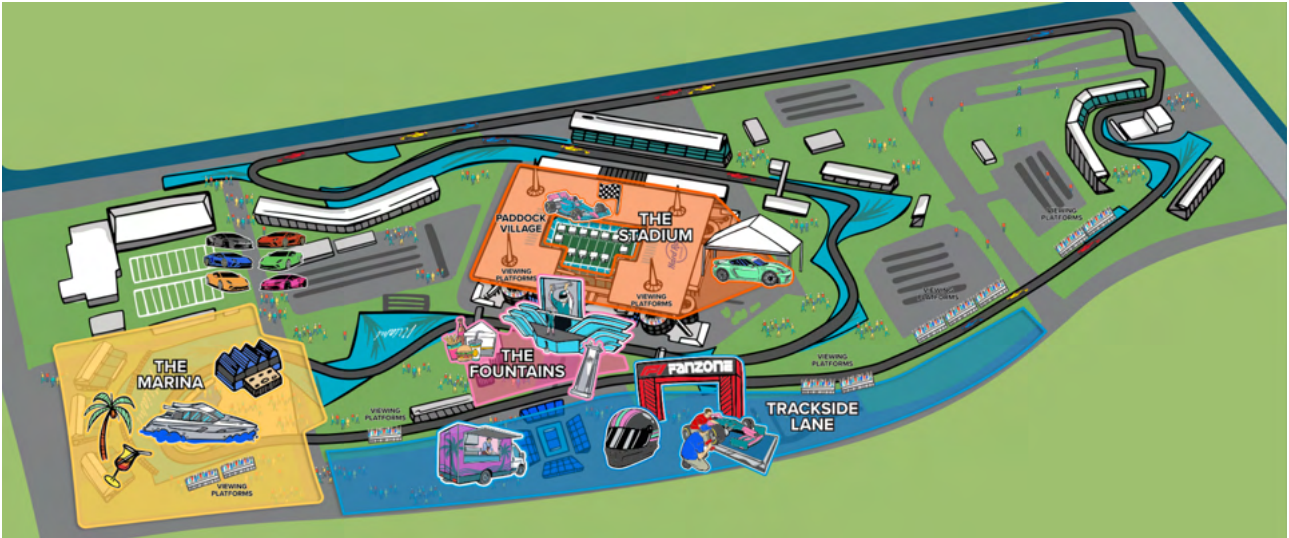

Promoter
South Florida Motorsports

Website: <https://f1miamigp.com/>



1. GENERAL INFORMATION

1.3 MIAMI INTERNATIONAL AUTODROME - SPECIFICATION & INFORMATION

CIRCUIT SPECIFICATIONS:

First Grand Prix	2022	
Circuit Length	5.41 km	
Number of Laps	57	
Race Distance	308.37 km	
Track Width	10 - 15.4 m	
Turns	19	12 left turns 7 right turns
Average Lap Speed	215 km/h	

FOR MORE INFORMATION:

Formula 1® Crypto.com Miami Grand Prix 2023 media website:	https://media.f1miamigp.com/
Formula 1® Crypto.com Miami Grand Prix 2023 website:	https://f1miamigp.com/

FOLLOW FORMULA 1® CRYPTO.COM MIAMI GRAND PRIX 2023:

Facebook:	www.facebook.com/F1Miami
Twitter:	@f1miami
Instagram:	@f1mia

1. 1 GENERAL INFORMATION

1.4 MIAMI - TRAVEL GUIDE

1.4.1 GREATER MIAMI & MIAMI BEACH SIGHTS & ATTRACTIONS - OVERVIEW

Tourism	https://www.miamiandbeaches.com/
Sand & Art Deco	For many, Miami Beach is the first stop to soak up the sunshine at iconic beaches, explore the Art Deco District near Ocean Drive and get a taste of South Beach's legendary scene, Mid Beach's glamorous resorts, and North Beach's laid-back vibe.
Explore Hip Enclaves	Just across Biscayne Bay, a different experience awaits when you explore Wynwood and the Miami Design District . Mural-splashed Wynwood is a hip, bustling neighborhood filled with buzzy restaurants, breweries, bars, and art galleries, while the Miami Design District is an upscale, alfresco shopping district with captivating public art and acclaimed fine-dining restaurants.
Arts & Architecture	The Downtown Miami/Brickell area is home to some of Miami's premier arts and cultural institutions, including the Pérez Art Museum Miami and the Phillip and Patricia Frost Museum of Science , which share a campus in Maurice A. Ferré Park overlooking Biscayne Bay. As you journey a bit further south, Coconut Grove and Coral Gables open to glorious architecture, lush tropical foliage, and one-of-a-kind attractions such as Vizcaya Museum and Gardens and the Venetian Pool .
Cultural Connections	Miami is also rich in Latin and Caribbean heritage. Visit Little Havana for a taste of Cuba, from the delicious fare at Versailles Restaurant to live music and salsa dancing at spots along Calle Ocho (Southwest 8 th Street). In Little Haiti , you can learn about Haitian culture among a hip, artsy crowd at the Little Haiti Cultural Arts Center and Caribbean Marketplace before heading out to a neighborhood gallery crawl. And Miami's Black heritage can be explored in Historic Overtown , whether it's at a performance at the Lyric Theater or breakfast at Jackson Soul Food .

<https://www.miamiandbeaches.com/neighborhoods>

1. GENERAL INFORMATION

1.4 TRAVEL GUIDE

1.4.2 BEST MUSEUMS IN MIAMI

<https://www.miamiandbeaches.com/things-to-do/art-and-culture/museums>

Miami Beach Area	
<p><u>The Bass</u> The Bass is Miami Beach’s renowned contemporary art museum and has an exhibition program that encompasses a wide range of media and artistic points of view.</p>	<p><u>The Wolfsonian-Florida International University</u> Located in the heart of South Beach’s historic Art Deco District, The Wolfsonian is one of the largest American university art collections devoted to design, propaganda, and the decorative arts.</p>
Downtown Miami Area	
<p><u>Pérez Art Museum Miami (PAMM)</u> With its vibrant lineup of exhibits, hands-on workshops, educational programs, lectures, and community events, the PAMM takes center stage as one of Downtown Miami’s most prominent cultural destinations.</p>	<p><u>Phillip and Patricia Frost Museum of Science</u> The groundbreaking museum opened in 2017 in Downtown Miami’s Maurice A. Ferré Park. The museum’s permanent exhibitions are dedicated to South Florida’s biodiversity, the physics of light, the human mind and body, and more.</p>
<p><u>HistoryMiami Museum</u> This premier cultural institution and Smithsonian Affiliate is committed to gathering, organizing, preserving, and celebrating Miami’s history as the unique crossroads of the Americas.</p>	
Wynwood / Design District	
<p><u>Wynwood Walls</u> When you visit Wynwood Walls, you’ll get a taste of Miami’s diverse art world. Adorned in everything from life-sized murals of the Dalai Lama and graffiti quotes to abstract painting and out-of-this-world sculptures, Wynwood Walls is as unique as it is creative.</p>	<p><u>Museum of Graffiti</u> The Museum exhibits, educates, and celebrates the thousands of graffiti artists who have transformed walls in our public spaces into vibrant masterpieces. Learn how the graffiti art movement started and how it emerged to become the fastest-growing art form of our time.</p>
<p><u>The Institute of Contemporary Art, Miami (ICA)</u> ICA is the neighborhood’s premier museum, showcasing contemporary art by local, emerging, and under-recognized artists.</p>	



Allapattah	
<p><u>Superblue Miami</u> At Superblue, they believe that art and creativity have the power to change how people understand the world we live in and have teamed up with artists who create experimental artworks that are as meaningful as they are breathtaking.</p>	<p><u>Rubell Museum</u> This museum, one of the world's finest contemporary art collections, features paintings, photographs, sculptures, and videos from 1980 to the present.</p>
North Miami Area	Coconut Grove Area
<p><u>Museum of Contemporary Art (MOCA)</u> MOCA North Miami presents contemporary art and its historical influences through exhibitions, educational programs, and collections.</p>	<p><u>Vizcaya Museum and Gardens</u> Named after one of the most captivating shorelines on the Spanish coast, Vizcaya Museum & Gardens captures jaw-dropping European extravagance in an enchanting American context.</p>

1.1 GENERAL INFORMATION

1.4 MIAMI - TRAVEL GUIDE

1.4.3 PARKS

<https://www.miamiandbeaches.com/things-to-do/parks-recreation/explore-nature-parks-gardens-in-miami>

Miami Beach/North Miami Beach	
<p><u>Oleta River State Park</u> Considered Florida's largest urban park, Oleta encompasses more than 1,000 acres of greenery set against Biscayne Bay, ideal for kayaking, biking, hiking, swimming and camping.</p>	<p><u>Miami Beach Botanical Garden</u> Located next to the Miami Beach Convention Center, the garden is part of the Miami Beach City Center Campus in the Miami Beach Convention Center district.</p>
Key Biscayne	
<p><u>Bill Baggs Cape Florida State Park</u> Just a 15-minute drive from Downtown Miami, Bill Baggs Cape Florida State Park is a natural paradise at the southern tip of Key Biscayne. Climb to the top of the lighthouse for fantastic views, walk along tree-lined trails and soak up the sun on the beach.</p>	<p><u>Marjory Stoneman Douglas Biscayne Nature Center</u> This non-profit conservation project is a wonderful place to bring the kids to enjoy a family outing or to learn a bit of biology from the expert staff. Their facility is a beautiful addition to the otherwise natural green oasis of Crandon Park.</p>
South Dade	
<p><u>Fairchild Tropical Botanic Garden</u> Fairchild Tropical Botanic Garden in Coral Gables is one of the premier botanic gardens in the country. Today, the garden's collection includes more than 3,400 species, including tropical fruit, orchids, butterflies, and native and exotic plants throughout its Uplands and Lowlands ecosystems and exhibits.</p>	<p><u>Fruit & Spice Park</u> Situated in South Dade's Redland region, the Fruit & Spice Park is a unique destination dedicated to cultivating tropical fruit trees in a lush, accessible and interactive environment.</p>
<p><u>Everglades National Park</u> Located at the southernmost tip of the Florida mainland, just before the Florida Keys, Everglades National Park is the largest subtropical wilderness in the U.S. and a UNESCO World Heritage Site.</p>	<p><u>Biscayne National Park</u> South Florida's natural beauty is legendary, dotted with ecosystems not found anywhere else in the U.S. One of the area's ecological highlights is the aquatic wonderland of Biscayne National Park.</p>

1.1 GENERAL INFORMATION

1.4 MIAMI - TRAVEL GUIDE

1.4.4 HISTORY

<https://www.miamiandbeaches.com/things-to-do/attractions/miamis-unique-historical-gems>

<p><u>Miami Design Preservation League</u> The Miami Design Preservation League (MDPL) is a non-profit resource for the historic preservation and enhancement of Miami Beach's unique architectural and cultural identity.</p>	<p><u>Ancient Spanish Monastery</u> Hidden in modern North Miami Beach, the Ancient Spanish Monastery takes us back. An enclave of European architecture and history, this Florida Heritage site has endured a long and interesting history to become the South Florida monument we know and love today.</p>
<p><u>Holocaust Memorial Miami Beach</u> The Holocaust Memorial Miami Beach serves as a permanent reminder of the six million Jews that perished at the hands of the Nazi regime during 1933 to 1945.</p>	<p><u>Black Archives - Historic Lyric Theater</u> The Lyric represents a point of pride for Miami's black community, and it will continue to celebrate the history and culture of Overtown in the years to come.</p>

1. 1 GENERAL INFORMATION

1.4 MIAMI - TRAVEL GUIDE

1.4.5 ADVENTURE

<https://www.miamiandbeaches.com/things-to-do/attractions/how-to-get-an-adrenaline-rush-in-miami>

On the Water	
<p><u>Thriller Miami Speedboat Adventures</u> Enjoy shoreline views of Biscayne Bay, Downtown Miami Skyline, Miami Beach, Fisher Island, Star Island mansions, and more on Thriller's 45-minute speedboat tours.</p>	<p><u>Ocean Force Adventures</u> Adventure sightseeing with expert local guides aboard a high-performance Zodiac RIB (boat) exploring secluded insider locations, popular landmarks, natural areas, and historical sites in Miami's Biscayne Bay.</p>
<p><u>Island Queen Cruises Inc.</u> Sit back and relax for an unforgettable bilingual narrated sightseeing cruise along Miami's spectacular coastal sites including the beautiful Downtown Miami skyline, PortMiami, Fisher Island, Miami Beach and "Millionaire's Row".</p>	<p><u>Biscayne Lady Yacht Charters</u> This yacht charter company offers yacht charter services tailored to clients' needs. They offer a selection of luxury yacht, sport yachts, party vessels, and sport fishing boats.</p>
<p><u>Eco Adventures Miami-Dade County Parks</u> Kayak and snorkel off Key Biscayne, bike through scenic trails or join a nighttime owl walk.</p>	
In the Sky	
<p><u>Miami Skydiving Center</u> Experience a true bird's eye unobstructed view of Miami at an elevation of two miles with the Miami Skydiving Center located at the Miami Executive Airport.</p>	<p><u>Miami Executive Helicopters</u> Experience the Miami skyline in style or take a voyage over the Keys for breathtaking vistas. Your pilot will deliver the play-by-play experience over headphones, as you soar over beautiful sights.</p>
<p><u>Sky Views Miami Wheel</u> Towering 176-feet tall above Miami's famous Bayside Marketplace, enjoy the breathtaking panoramic views of beautiful Downtown Miami, the surrounding Metropolitan area and Biscayne Bay.</p>	
Animals	
<p><u>Zoo Miami</u> Often rated one of the country's top zoos, this 750-acre gem showcases more than 3,000 animals, including koalas, tigers, and elephants in large open-air exhibits.</p>	<p><u>Monkey Jungle</u> Monkey Jungle is a unique eco-show park and discovery center established in 1935 in a natural subtropical forest in southern Miami-Dade County, where the Jungle wildlife live as much as they would in their native habitats.</p>



Daring	
<p><u>Homestead Miami Speedway</u> Previously the host of the annual NASCAR Championship, South Dade's Homestead Miami Speedway.</p>	<p><u>Lock & Load Miami Machine Gun Experience</u> Shoot machine guns and feel the adrenaline rush in a safe, controlled environment at this state-of-the-art facility.</p>
	<p><u>Axe Habits</u> Get the blood pumping at Axe habits, where you can compete to see who tosses axes best in Downtown.</p>
Airboat Tours & Attractions	
<p><u>Miccosukkee Indian Village & Airboat Tours</u> - Be captivated by live alligator demonstrations and explore the Everglades on airboat rides with guides who point out wildlife and stop at an authentic hammock camp.</p>	<p><u>Everglades Alligator Farm</u> Take a day trip through South Dade to visit Homestead's Everglades Alligator Farm. During a visit, you can watch an alligator show, a snake show, and witness an alligator feeding.</p>
<p><u>Coopertown Everglades Airboat Tour & Restaurant</u> Offering airboat rides and alligator exhibitions since 1945. Professional guides lead tours through Hardwood Hammock to see wildlife in its native Everglades environment.</p>	<p><u>Everglades Safari Park</u> From airboats to nature walks, wildlife shows to gator bites, Everglades Safari Park offers family fun in the warm Florida sun, all year long.</p>

1. 1 GENERAL INFORMATION

1.4 MIAMI - TRAVEL GUIDE

1.4.6 BEACHES

<https://www.miamiandbeaches.com/things-to-do/beaches/miamis-best-beaches>

Miami Beach Area	
<p>Haulover Beach Park This 1.5-mile beach is located north of Miami Beach, between the Intracoastal Waterway and Atlantic Ocean. Haulover Beach Park is noted for blue waters, soft sand, and plenty of picnic areas.</p>	<p>South Beach It's hard to imagine Miami without visions of South Beach swirling in your head. This legendary stretch of beach runs from the southern tip of the island to 23rd Street.</p>
<p>South Pointe Park South Pointe Park is a beautiful green space at the southern tip of Miami Beach. It offers stunning panoramic views of the South Beach shoreline, PortMiami's cruise ships, Downtown Miami's skyline and Fisher Island.</p>	<p>Sunny Isle Beach Situated just north of Bal Harbour and Haulover Park, Sunny Isles Beach is bordered by the Atlantic Ocean to the east and the Intracoastal Waterway to the west.</p>
Key Biscayne	
<p>Bill Baggs Cape Florida State Park Beach Bill Baggs Cape Florida State Park, at the tip of Key Biscayne, is a treasure. With rugged sand dunes leading to an uncrowded beach and unlimited ocean views, it's a piece of unspoiled and natural old Florida.</p>	<p>Crandon Park Beach Located on the idyllic barrier island of Key Biscayne, right on Biscayne Bay, Crandon Park is popular for its beautiful beach, rich coastal environmental, unique fossilized mangrove reef, protected wetlands, birding sites and extensive range of sports and outdoor activities.</p>
South Dade Area	
<p>Matheson Hammock Park One of Miami-Dade's most reassured county parks, Matheson Hammock Park, sits on a peninsula that extends into Biscayne Bay. The park spans 630 acres of coastal Miami just south of Coral Gables, surrounding part of Fairchild Tropical Botanic Garden.</p>	

1. 1 GENERAL INFORMATION

1.4 MIAMI - TRAVEL GUIDE

1.4.7 RESTAURANTS & DINING SUGGESTIONS

<https://www.miamiandbeaches.com/things-to-do/restaurants?filter=dining&orderBy=Random>

Miami Gardens	
<p><u>Lorna's Caribbean & American Grill</u> Lorna's Caribbean has been a Miami staple since 2006. The namesake Ms. Lorna took her family recipes, added some flare, and the love she nurtured her children with, and created a flavor powerhouse.</p>	<p><u>Chef Creole Miami Gardens</u> Chef Wilkinson Sejour has grabbed his native Creole cuisine by the fishtail and created Island dishes for food connoisseurs. Born in the Bahamas to Haitian parents, Wilkinson has taken the best of the Caribbean and added a Creole twist.</p>
Miami Beach	
<p><u>Juvia</u> Juvia offers dishes that are a combination of French, Japanese and Peruvian cooking styles. The ultramodern décor, with a living wall backdrop, sets the stage for top-notch dining as the city lights twinkle below.</p>	<p><u>Time-Out Market Miami</u> South Beach's destination for eating and drinking that features the city's top chefs, most-talked-about restaurants, and the buzziest bars—plus the latest in arts and culture all huddled together under one roof.</p>
<p><u>Joe's Stone Crab Restaurant</u> Established in 1913, two years before Miami Beach would even become incorporated, Joe's has withstood the test of time. Opened as "Joe's Restaurant" by Joe and Jennie Weiss, local seafood was served up on their front porch after being prepared in their kitchen.</p>	<p><u>Nikki Beach</u> The brand's flagship location is comprised of a large oceanfront complex that features a beach club, award-winning restaurant, cabana bar, garden area café and second floor nightclub.</p>
<p><u>Baoli</u> From Mr. Hospitality Group, Bâoli Miami is a restaurant, lounge, and nightclub on Collins Avenue that reigns over the culinary and nightlife scene in South Beach, importing a truly European style of partying.</p>	<p><u>Strawberry Moon</u> Strawberry Moon is a new contemporary, high-energy Mediterranean restaurant, bar, and day-to-night swim club tucked above the busy streets of South Beach at the newly opened Goodtime Hotel.</p>
<p><u>Gianni's At The Villa</u> The Villa Casa Casuarina is the former Versace mansion, and offers the best service, oversized Italian marble bathrooms, a gold-clad pool, a lavish rooftop lounge and private bars. Gianni's at The Villa offers a one-of-a-kind dining experience in an iconic setting.</p>	<p><u>Villa Azur Restaurant & Lounge</u> The enchanted open-aired courtyard is one of the most distinguishing features of the restaurant that enables guests to dine and dance under the stars, creating an atmosphere sans rival.</p>
<p><u>Carbone</u> Ritzy leather banquettes, over-the-top chandeliers, curated art and jewel-tones fabrics create a swanky atmosphere at Carbone, the fourth outpost of this popular Michelin-starred (New York) restaurant.</p>	<p><u>Prime 112</u> From distinguished restaurateur and back-to-back James Beard Award Semifinalist Myles Chefetz, this restaurant takes the steak-house concept to the next level.</p>

Promoter

South Florida Motorsports

Website: <https://f1miamigp.com/>

19

<p><u>Smith and Wollensky</u> With USDA Prime dry-aged steaks, an award-winning wine list, and some of the best views in South Beach, this restaurant is a favorite of local and visitors alike.</p>	<p><u>The Surf Club Restaurant by Chef Thomas Keller</u> The Surf Club Restaurant by Chef Thomas Keller is located within The Surf Club. The à la carte menu interprets classic Continental cuisine for a contemporary audience.</p>
<p><u>Nobu</u> Situated within the Eden Roc Miami Beach is the Nobu Hotel, a concept that has been crafted and cultivated by world-famous Japanese chef, Chef Nobu Matsuhisa and Academy Award-winning actor, Robert De Niro.</p>	<p><u>STK Miami Beach</u> Located in the heart of Miami Beach, STK blends a modern steakhouse with a chic lounge. Crocodile tiles, theatrical table lighting and a DJ create a luxurious and dynamic ambience</p>
<p>Historic Overtown</p>	
<p><u>Red Rooster Overtown</u> Located in the heart of Overtown, Red Rooster serves comfort food celebrating the roots of American cuisine and the diverse culinary traditions of the neighborhood.</p>	<p><u>Lil Greenhouse Grill</u> Enjoy smoked, grilled and freshly prepared seafood, barbeque, salads, and sandwiches.</p>
<p>Little Havana</p>	
<p><u>Café La Trova</u> The world-famous Julio Cabrera and his team of Cantineros bring to life the retro Cuba atmosphere with their artisanal, handcrafted cocktails. James Beard Award Winning Chef Michelle Bernstein lends her culinary prowess with a contemporary take on Cuban-styled dishes.</p>	<p><u>Versailles Restaurant</u> Serving authentic Cuban cuisine since 1971, Versailles Restaurant is a Little Havana landmark known as a gathering place for the Cuban diaspora as well as a neighborhood standby where locals and visitors can count on friendly service and traditional Cuban fare for breakfast, lunch and dinner.</p>
<p>Design District</p>	
<p><u>COTE Miami</u> High-energy <u>COTE Miami</u> combines the sleek glamour of an American steakhouse with the interactive experience of Korean barbeque</p>	<p><u>L'Atelier de Joël Robuchon</u> L'Atelier's name refers to a craftsman's workshop, emphasizing Chef Robuchon's hallmark of elevating the simplest of dishes into something extraordinary using pristine ingredients, immaculate technique, and abundant creativity.</p>
<p><u>Swan & Bar Bevy</u> Located in the heart of Miami's Design District, Swan is an indoor/outdoor dining destination from hospitality mavens David Grutman and Pharrell Williams.</p>	<p><u>MIA Market</u> MIA Market is a chef-driven food hall featuring a thoughtfully curated mix of local food and beverage talent.</p>
<p><u>Michael's Genuine Food & Drink</u> Nestled in the heart of the Design District, Michael's Genuine Food & Drink offers a gourmet take on comfort food classics.</p>	<p><u>Le Jardinier</u> Le Jardinier's modern, light-filled space and lush outdoor dining area are meant to evoke a fun, tropical garden in the heart of The Miami Design District.</p>

Wynwood	
<p><u>KYU</u> Chef Michael Lewis and general manager Steven Haigh bring a fresh concept with the wood-fired Asian grill that features a diverse menu and focuses on professional yet relaxed service and a commitment to green practices.</p>	<p><u>Smorgasburg Miami</u> Located in the heart of Wynwood, Smorgasburg Miami is the South Florida outpost of the largest weekend open-air food market in America and features 6+ of the best up-and-coming food vendors in Miami and beyond. (Please note that this is only open on Saturdays from 11-6pm).</p>
<p><u>1-800-Lucky</u> The sprawling indoor-outdoor Asian food hall 1-800-Lucky draws a hip crowd that craves dumplings, late-night DJ beats and endless sake.</p>	<p><u>R House</u> Situated in the heart of the Wynwood Arts District, Miami's graffiti-lined cultural core, R House is one of the original pioneers Wynwood restaurants that is known for their lively dinner and brunch scene.</p>
<p><u>Wynwood Kitchen & Bar</u> Known for their visually striking décor and art, will have you in awe as soon as you step inside and explore.</p>	<p><u>Uchi Miami</u> Uchi Miami is the Miami outpost of Austin's legendary sushi restaurant opened by sushi-master and James Beard award-winning Chef Tyson Cole.</p>
Downtown Miami Area	
<p><u>Komodo</u> Komodo provides the allure of an ultrachic environment paired with Pan-Asian cuisine that is second to none.</p>	<p><u>Zuma Miami</u> Experience chef Rainer Becker's international renowned style of modern Japanese izakaya at Zuma.</p>
<p><u>Fleming's Prime Steakhouse & Wine Bar - Brickell</u> Guests will find a place for locals and visitors to enjoy an exceptional selection of premium steaks and an expertly curated list of wines by the glass.</p>	<p><u>La Mar by Gastón Acurio</u> Savor Peru's multicultural cuisine at La Mar by Gastón Acurio, an upscale waterfront eatery located in the luxe Mandarin Oriental Hotel on Brickell Key.</p>
<p><u>Sexy Fish</u> Experience high-end glamour, surrealist décor, and opulent culinary majesty inspired by the oceans of Asia.</p>	<p><u>Boulud Sud</u> Boulud Sud is Chef Daniel Boulud's vibrant celebration of the sun and the sea and draws inspiration from the coastal Mediterranean area.</p>
<p><u>Seaspice</u> This brasserie and lounge is a waterfront restaurant with an emphasis on freshly sourced seafood, harmonious flavor pairings, and thoughtful presentations.</p>	<p><u>Kiki On The River</u> A Greek restaurant in Miami featuring modern Greek cuisine and an authentic Mediterranean island-inspired riverfront setting.</p>
<p><u>Amara at Paraiso</u> Count on spectacular bay views served up with brunch, lunch, or dinner at this restaurant by James Beard award-winning Chef Michael Schwartz.</p>	<p><u>NIU Kitchen</u> Straddling the line between madness and genius, NIU Kitchen has but a single purpose in mind—to feed your imagination.</p>

Coconut Grove	
<p><u>Ariete</u> Ariete is a charming indoor-outdoor restaurant helmed by another rock-star Miami chef, Michael Beltran. Here, everything revolves around the wood-fired grill, as Beltran proudly weaves his Cuban heritage into innovative American dishes.</p>	<p><u>Glass & Vine</u> To fully experience the energy of the Grove, take a seat on the massive patio at Glass & Vine, a casual garden oasis overlooking Peacock Park with glimpses of Biscayne Bay in the distance.</p>
<p><u>Peacock Garden Bistro</u> This restaurant, with a beautiful outdoor patio, is perfect for a delicious meal, a quick snack or just an aperitif or glass of Prosecco.</p>	<p><u>Key Club</u> The Key Club is an all-new take on a classic American bar and grill, located in the heart of Miami's historic Coconut Grove.</p>
<p><u>Sadelle's</u> Located in the heart of Coconut Grove, Sadelle's is the latest outpost of Major Food Group's acclaimed all-day dining institution, which was originally founded in downtown Manhattan in 2016.</p>	<p><u>Bellini Restaurant and Bar</u> Inspired cuisine from around Italy, Bellini's menus are all crafted personal favorites. In keeping the vision of Mr. C Hotels, the atmosphere is approachable, fun and inviting without compromising the level of service.</p>
Coral Gables	
<p><u>Mamey</u> Inspired by Chef Patel's travels throughout Asia, Polynesia and the Caribbean, Mamey showcases the exotic flavors and spices commonly found in the islands with ingredients sourced directly from Chef's own Rancho Patel.</p>	<p><u>Forte by Chef Adrienne</u> Chef Adrienne Calvo, the young star chef who is best known for delivering her Maximum Flavor launched Forte and offers guests a premier Italian culinary experience that pays homage to Calvo's mother by bearing her maiden name.</p>
<p><u>Fontana Italian Biltmore Hotel Miami</u> Fontana offers Italian-inspired cuisine punctuated with local and seasonal ingredients and an exceptional wine list.</p>	<p><u>Caffe Abbracci</u> True to his native Venezia, owner Nino Perneti continues his time-honored tradition of bringing the enjoyment of quintessential classic Northern Italian dishes to the palates of discerning patrons.</p>
<p><u>Zucca Restaurant</u> Located at the iconic Hotel St. Michel in the heart of Coral Gables, Zucca is a ristorante and bar that delivers authentic, artisanal Italian cuisine from a diverse range of the country's regions, within a masterfully crafted, modern space.</p>	<p><u>Graziano's Market Coral Gables</u> This restaurant is a traditional Argentine steakhouse. With more than 20 years of experience, the restaurant offers an unforgettable dining experience that will satisfy any meat and wine lover.</p>
South Dade	
<p><u>Red Fish by Chef Adrienne</u> Red Fish by Chef Adrienne is located inside historic Matheson Hammock Park, on the shore of Biscayne Bay. This restaurant features a menu that mixes new American seafood with traditional fish house classics.</p>	<p><u>Schnebly Redlands Winery</u> This winery in Miami's Redland tropical countryside offers tours and wine tastings around natural coral waterfalls surrounded by lush tropical foliage.</p>

1. 1 GENERAL INFORMATION

1.4 MIAMI - TRAVEL GUIDE

1.4.8 SHOPPING SUGGESTIONS

<https://www.miamiandbeaches.com/things-to-do/shopping>

<p><u>Aventura Mall</u> Aventura Mall is not only one of Greater Miami's best places to shop; it's also a must-visit destination where art, food, beautifully designed spaces and, of course, sought-after brands come together to create an only-in-Miami experience.</p>	<p><u>Bal Harbour Shops</u> This exquisite collection of designer boutiques and restaurants in a tropical garden setting is a favorite playground for socialites, fashionistas, and celebrities.</p>
<p><u>Miami Design District</u> The Miami Design District is a luxury shopping destination dedicated to innovative fashion, design, architecture, and dining experiences.</p>	<p><u>Dolphin Mall</u> At this large outlet shopping center, shoppers can experience the best in life with its fusion of fashion, flavor, and fun.</p>
<p><u>Bayside Marketplace</u> Located on Biscayne Bay in the heart of Downtown Miami, visitors of Bayside Marketplace can experience the real Miami - home to impeccable international cuisine, fine shops and exotic music in a beautiful, waterfront setting.</p>	<p><u>Lincoln Road Shopping District</u> This epic outdoor Miami Beach pedestrian thoroughfare features premier shopping, restaurant, and nightlife as well as South Beach classic architecture and Miami style.</p>
<p><u>Brickell City Centre</u> Luxury brands are well represented with premium, contemporary and new-to-market brands in the mix.</p>	<p><u>Miracle Mile Coral Gables Shopping District</u> Features quality shops, art galleries, boutiques, restaurants, and a live theater in a lushly landscaped environment of tree-lined streets.</p>



1. GENERAL INFORMATION

1.4 MIAMI - TRAVEL GUIDE

1.4.9 TRANSPORTATION/ AIRPORT/ TAXIS/ CAR RENTAL

<https://www.miamiandbeaches.com/plan-your-trip/transportation>

Airport	
Miami International Airport (305) 876-7000	
Taxis From the Airport https://www.miamiandbeaches.com/plan-your-trip/transportation/how-to-use-uber-lyft-and-private-car-services	
Uber	Lyft
Miami Taxi Services	
Rental Cars	
RentalCars.com - the world's largest online car rental booking service - is making renting a car easier and more convenient, than ever before.	MIA Rental Car Center -You can access the MIA Rental Car Center by taking the MIA Mover right from Miami International Airport. Find the MIA Mover by taking the airport's third-level Skyride and moving walks to the MIA Mover Station, located between the Dolphin and Flamingo Garages.
Avis Car Rental	Hertz Car Rental
Enterprise Rental Car	Alamo Car Rental



1. GENERAL INFORMATION

1.4 MIAMI - TRAVEL GUIDE

1.4.10 EMERGENCY INFORMATION/ HOSPITALS

EMERGENCY NUMBERS

<https://www.miamiandbeaches.com/plan-your-trip/medical-tourism>

Emergency Numbers	
Emergency 911	Fire Rescue Division 888-772-3207
Hospitals	
<u>Jackson Health System</u>	<u>Baptist Health South Florida</u>
<u>HCA Florida Aventura Hospital</u>	<u>Nicklaus Children's Hospital</u>

1. GENERAL INFORMATION

1.4 MIAMI - TRAVEL GUIDE

1.4.11 ADDITIONAL INFORMATION

Area & Population

Greater Miami and Miami Beach is spread over 2,431 square miles (6,296 square kilometers) of land and water at the southeastern tip of the Florida peninsula. The Intracoastal Waterway separates the Miami mainland and Miami Beach, located on the Atlantic Ocean. More than 2.7 million people reside here, bringing to the area a rich cultural diversity.

Local Weather			
Month	Fahrenheit Degrees Min/Max	Celsius Degrees Min/Max	Average Precipitation Inches/cm
January	59/75	15/24	2.01/5.11
February	60/76	16/24	2.08/5.28
March	64/79	18/26	2.39/6.07
April	68/83	20/28	3.03/7.7
May	72/85	22/29	6.21/15.77
June	75/88	24/31	9.33/23.7
July	77/89	25/32	5.70/14.48
August	77/89	25/32	7.58/19.25
September	76/88	24/31	7.63/19.38
October	72/85	22/29	5.64/14.33
November	67/80	19/27	2.66/6.76
December	62/77	16/24	1.83/4.65

Currency

The national currency of Miami, Florida is the American Dollar (USD) and supplied by the U.S. Federal Reserve. American paper currency come in seven denominations: \$1, \$2, \$5, \$10, \$20, \$50, and \$100.

Language

English is the official language in Miami, but due to the large immigration of people from various Spanish speaking regions, Spanish is also a dominant language and is spoken by 60% of the population.

Gratuities

Customarily, gratuities of 18 to 20 percent are paid to hospitality industry personnel who render personal services. You may find a restaurant has already added the gratuity to the bill.

Taxes

Sales tax in Miami-Dade County is 7 percent. Hotel taxes (including sales tax) range from 11 to 14 percent depending on the location of the property.

Driving & Traffic Regulations

Texting and driving is prohibited in Florida. U.S. law stipulates driving on the right-hand side of the road and passing on the left. Right turns are permitted at red lights unless otherwise indicated. Always note posted speed limits. All persons riding in an automobile are required to wear seatbelts. Children under five years of age must be fastened securely in government-approved child car seats.

Division of Drivers Licenses: 305/229-6333. The State of Florida recognizes valid U.S. driver licenses, international driver licenses and valid licenses in other countries.

Tow-away Zones: Tow-away zones are indicated by signs posted at the curb.

Liquor Laws & Smoking

The legal drinking age is 21. Smoking and vaping are prohibited inside restaurants in Miami-Dade County.

The Concierge

Your hotel concierge can arrange all kinds of services, often while you are out sightseeing or attending a business meeting. **The Southern Florida Concierge Association: 888/528-1555, info@sfcasonline.com, sfaonline.com**

Smoking

All restaurants, including attached bars, are 100% smokefree. Smoking is permitted in freestanding bars that earn less than 10% of their income from food. No restrictions on hotel and motel rooms.

Electricity

The standard voltage is 120 V and the standard frequency is 60 Hz. In the U.S., the power plugs and sockets are of type A and B, which is the plug that has 2 rectangular pins (A) and sometimes a third circular pin (B).

Time Zone

Miami, FL is Eastern Daylight Time (EDT)

Telephones

+1 is the international code used to dial to USA. Miami mobile phone numbers have 10 digits and most mobile numbers start with 305, 645, and 786. All 10 digits must be dialed for calls within Miami. For example: 305-123-XXXX. When calling from outside the US, you will need to dial +1 (the US country code) + (US area code) + (7-digit US local phone number). For example: +1 305-123-XXXX.

2. MEDIA SERVICES RESPONSIBILITIES

ORGANISATION

Organising Body

South Florida Motorsports
Tyler Epp (President)
347 Don Shula Drive
Miami Gardens
Florida 33056
USA
Email: info@f1miamigp.com
Phone : ~~305-943-RACE (7223)~~

Managing Partner
Formula 1 Crypto.com
Miami Grand Prix

Tom Garfinkel

President

Tyler Epp

RACE TRACK

Operating Company

South Florida Motorsports
Miami International Autodrome
Tyler Epp (President)
347 Don Shula Drive
Miami Gardens
Florida 33056
USA

Clerk of the Course F1
Deputy Clerk of the Course
W Series
Deputy Clerk of the Course
PSCNA

Paul Walter
Morgan Healey
Randy Hembrey

2. MEDIA SERVICES

ACCREDITATION AND MEDIA CENTRE

ACCREDITATION

Location The Media Accreditation Centre is located at 24 Hr Fitness: 19371 NW 27th Ave, Miami Gardens, FL 33056 [MAP](#)

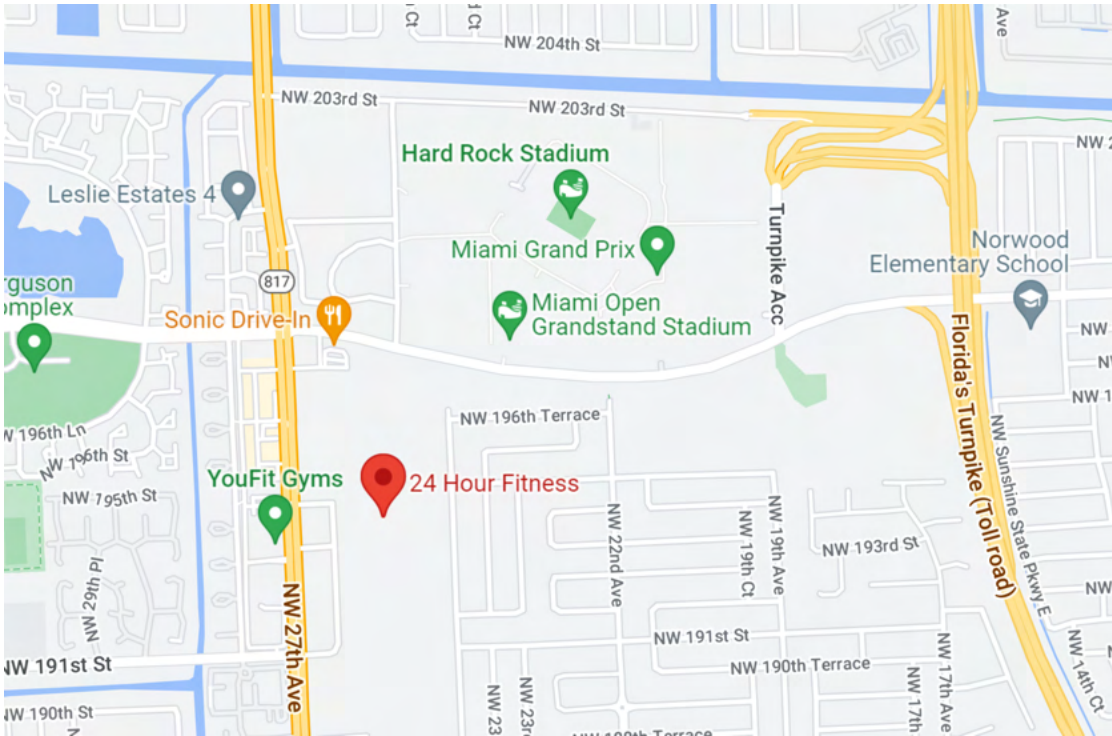

Opening hours	Wednesday, 3rd May	09:00 hrs - 18:00 hrs (FIA Media Accreditation to be available from 14:00)
	Thursday, 4th May	08:00 hrs - 18:00 hrs
	Friday, 5th May	08:00 hrs - 16:00 hrs
	Saturday, 6th May	08:00 hrs - 14:00 hrs
	Sunday, 7th May	08:00 hrs - 13:00 hrs (National Media & VIP Pass collection only)

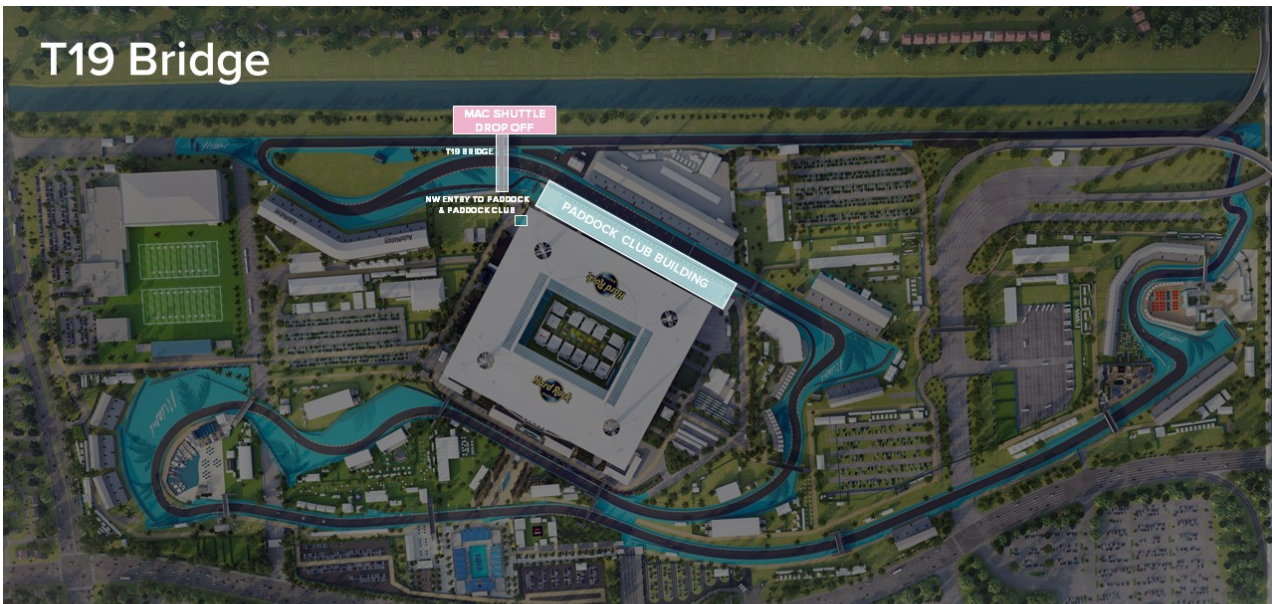
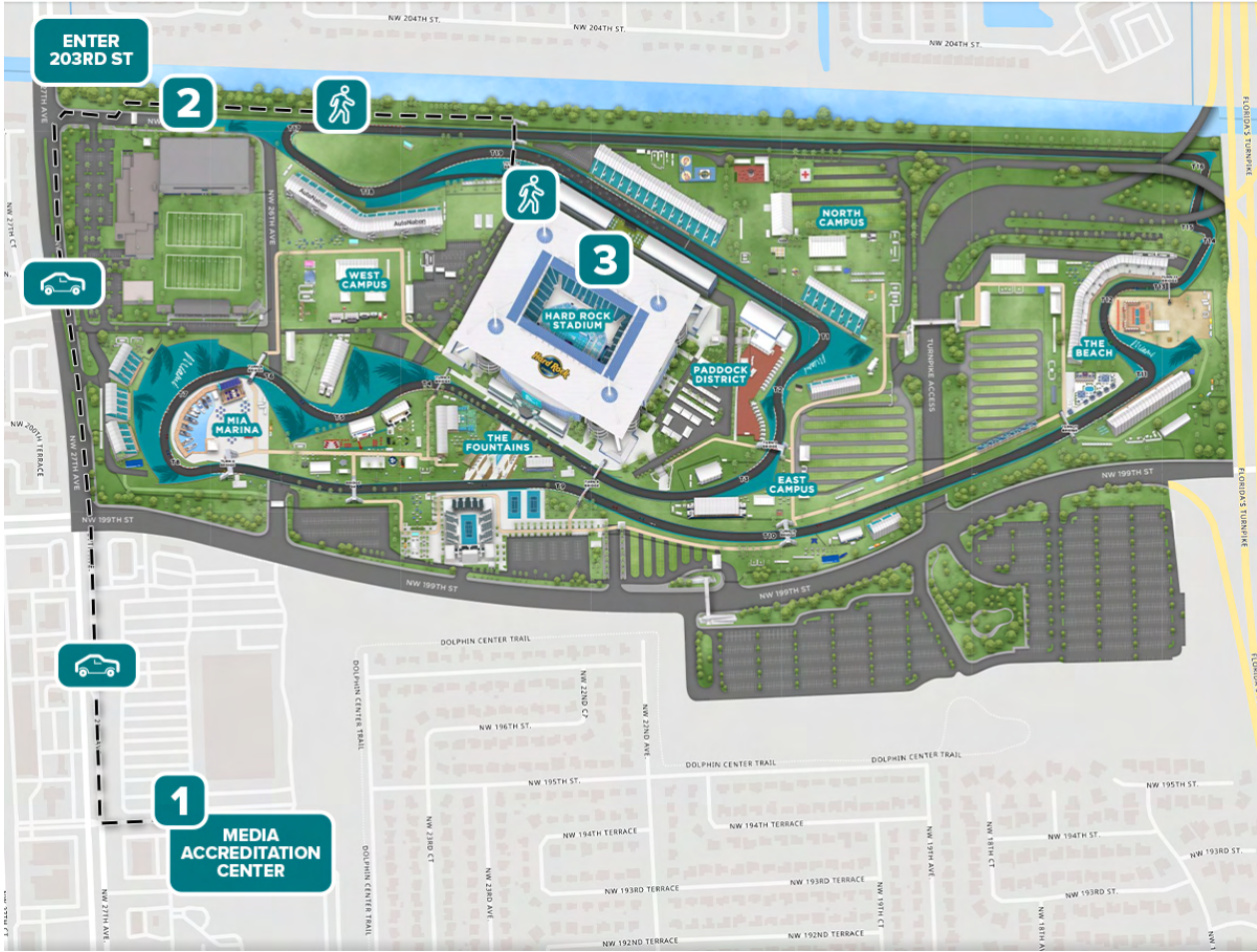

Promoter
South Florida Motorsports

Website: <https://f1miamigp.com/>



MEDIA CENTRE

National Press Officer	Brett Brecheisen bbrecheisen@dolphins.com
Media Centre Manager	Egbert Thamm egbert@ankrush.com
National Media & PR	Anne Noland anoland@dolphins.com
International Media & PR	Carla Corbet carla@ankrush.com
Media Accreditation Centre Coordination	Fiona Rees fiona@ankrush.com

2. MEDIA SERVICES

MEDIA CENTRE & PHOTOGRAPHERS AREA

MEDIA CENTRE

Location The Media Centre is located in between NW and SW corner on 200 level of the Hard Rock Stadium.

Opening Hours	Wednesday, 3 rd May	14:00 hrs - 18:00 hrs
	Thursday, 4 th May	09:00 hrs - 20:00 hrs
	Friday, 5 th May	07:00 hrs - 23:00 hrs
	Saturday, 6 th May	07:00 hrs - 23:00 hrs
	Sunday, 7 th May	07:00 hrs - until the last journalist/photographer leaves

JOURNALISTS & PHOTOGRAPHERS AREA

- 330 seats
- 400 lockers

Please obtain a key from the receptionist for the lockers.

Photographer Shuttle Route: Please refer to the schedule on the official notice board in the Photographers' room.

Operating Hours: Please refer to the schedule on the official notice board in the Photographers' room.

Red Zones: Please refer to the schedule on the official notice board in the Photographers' room.

Photographers' Towers: Please refer to the schedule on the official notice board in the Photographers' room.

2. MEDIA SERVICES

PRESS CONFERENCES

The Media Centre will host four official F1 Fédération Internationale de l'Automobile (FIA) press conferences during the race weekend as outlined below. All press conferences will follow a hybrid format, taking place in the press conference room and can also be accessed virtually via zoom.

Thursday, 15:00 - 16:05 hrs

- Hybrid Press Conference for 10 drivers in groups of five, chosen by the FIA F1 Media Delegate. Each session is 30 minutes long followed by a break of five minutes.

Friday, 15:30 - 16:30 hrs

- Hybrid press Conference for six team personalities, in two groups, chosen by the FIA F1 Media Delegate, each 30 minutes.

Saturday, following the qualifying sessions:

- TV on-track interview with the top three drivers of the qualifying session.

Saturday, after the TV on-track interview:

- Post-Qualifying hybrid Press Conference with the top three drivers of the qualifying session.

Sunday, before the podium celebrations:

- TV interview with the top three finishing drivers.

Sunday, after the podium celebrations:

- Post-Race hybrid Press Conference with the top three finishing drivers.

All press conferences will be transmitted into the Media Centre.



2. MEDIA SERVICES

PHOTOGRAPHERS SHUTTLE

Photographers Shuttle

Photographers will be asked to meet at the specified departure location to be taken to photo spots via the track before each session. Following track action, photographers will be collected. Please refer to the Official Photographers noticeboard for timetable and departure location.

2. MEDIA SERVICES

MEDIA TRANSPORT & SHUTTLES

Car Park Information

Media parking is in lot 8, via 203rd Street along Snake Creek.
Golf carts will be operational between the car park & bridge 19 that crosses the track.

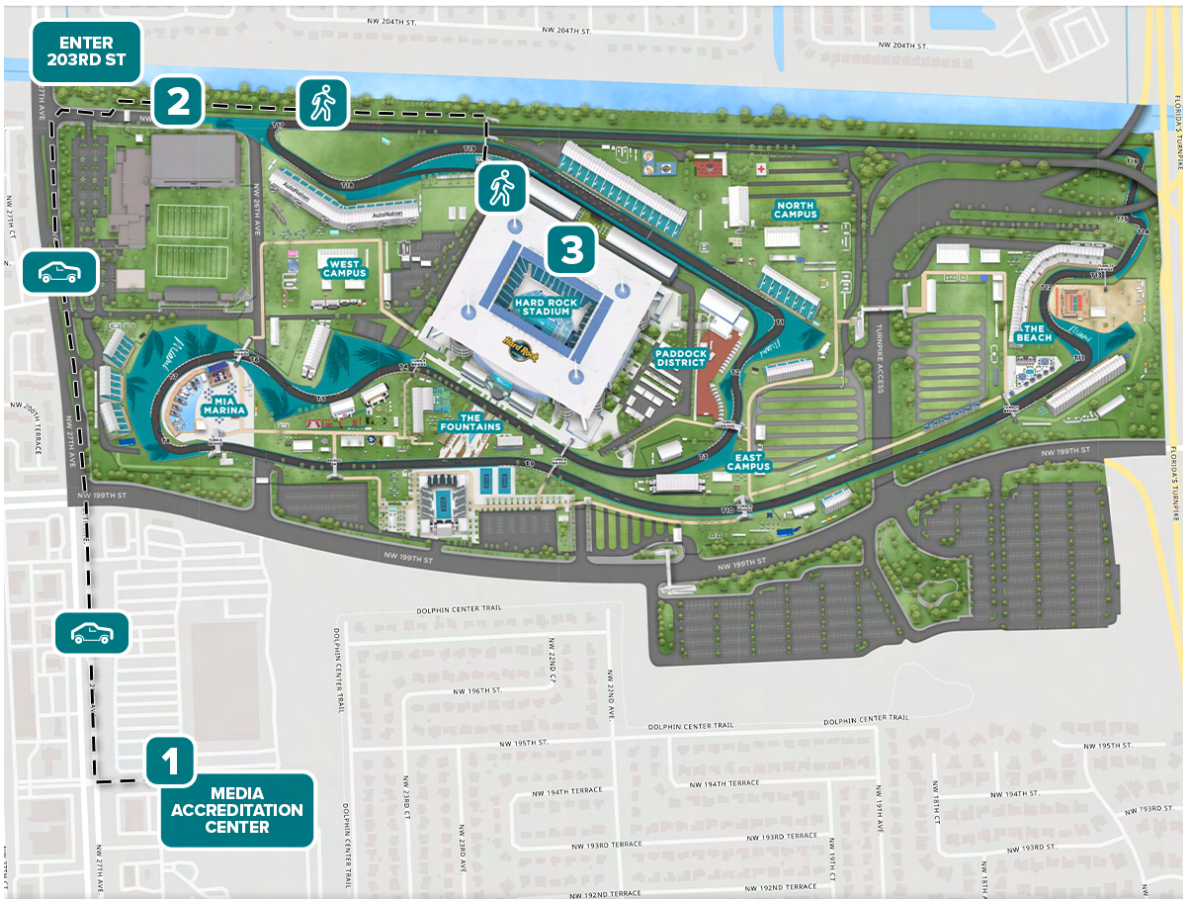

SHUTTLES

Complimentary shuttle buses will be running from the media hotels (DoubleTree by Hilton Hotel - Sawgrass Mills) between Wednesday - Sunday. Please see times displayed in the hotel reception and media centre for departure timings.

Shuttles will be operational between the Media Accreditation Centre (MAC) and Bridge 19 at the circuit between Wednesday 3 May - Sunday 8 May.

RIDE-SHARE APPS & TAXIS

If you are planning to arrive or depart via a ride-share app, please utilise the Media Accreditation Centre as a drop-off/collection location. Here media can hop on one of the shuttles by showing your media pass.

3. 2023 FIA FORMULA 1 WORLD CHAMPIONSHIP™

3.1 CALENDAR

03-05 Mar	GULF AIR BAHRAIN GRAND PRIX	Sakhir
17-19 Ma	STC SAUDI ARABIAN GRAND PRIX	Jeddah
31 Mar-02 Apr	ROLEX AUSTRALIAN GRAND PRIX	Melbourne
28-30 Apr	AZERBAIJAN GRAND PRIX	Baku
05-07 May	CRYPTO.COM MIAMI GRAND PRIX	Miami
19-21 May	GRAN PREMIO DELL' EMILIA ROMAGNA	Imola
26-28 May	GRAND PRIX DE MONACO	Monte Carlo
02-04 Jun	GRAN PREMIO DE ESPAÑA	Barcelona
16-18 Jun	GRAND PRIX DU CANADA	Montreal
30 Jun-02 Jul	GROSSER PREIS VON ÖSTERREICH	Spielberg
07-09 Jul	ARAMCO BRITISH GRAND PRIX	Silverstone
21-23 Jul	HUNGARIAN GRAND PRIX	Budapest
28-30 Jul	BELGIAN GRAND PRIX	Spa
25-27 Aug	HEINEKEN DUTCH GRAND PRIX	Zandvoort
01-03 Sep	GRAN PREMIO D'ITALIA	Monza
15-17 Sep	SINGAPORE AIRLINES SINGAPORE GRAND PRIX	Singapore
22-24 Sep	LENOVO JAPANESE GRAND PRIX	Suzuka
06-08 Oct	QATAR GRAND PRIX	Losail
20-22 Oct	LENEVO UNITED STATES GRAND PRIX	Austin
27-29 Oct	GRAN PREMIO DE LA CIUDAD DE MÉXICO	Mexico City
03-05 Nov	ROLEX GRANDE PRÊMIO DE SÃO PAULO	São Paulo
16-18 Nov	HEINEKEN SILVER LAS VEGAS GRAND PRIX	Las Vegas
24-26 Nov	ETIHAD AIRWAYS ABU DHABI GRAND PRIX	Yas Marina

3. 2023 FIA FORMULA 1 WORLD CHAMPIONSHIP™

3.2 DRIVERS' ENTRY LIST

No	Driver	Country	Team
1	Max Verstappen	Netherlands	Oracle Red Bull Racing
11	Sergio Perez	Mexico	Oracle Red Bull Racing
16	Charles Leclerc	Monaco	Scuderia Ferrari
55	Carlos Sainz	Spain	Scuderia Ferrari
44	Lewis Hamilton	Great Britain	Mercedes-AMG Petronas F1 Team
63	George Russell	Great Britain	Mercedes-AMG Petronas F1 Team
10	Pierre Gasly	France	BWT Alpine F1 Team
31	Esteban Ocon	France	BWT Alpine F1 Team
81	Oscar Piastri	Australia	McLaren F1 Team
4	Lando Norris	Great Britain	McLaren F1 Team
77	Valtteri Bottas	Finland	Alfa Romeo F1 Team Stake
24	Zhou Guanyu	China	Alfa Romeo F1 Team Stake
14	Fernando Alonso	Spain	Aston Martin Aramco Cognizant Formula 1 Team
18	Lance Stroll	Canada	Aston Martin Aramco Cognizant Formula 1 Team
20	Kevin Magnussen	Denmark	Moneygram Haas F1 Team
27	Nico Hulkenberg	Germany	Moneygram Haas F1 Team
45	Nyck de Vries	Netherlands	Scuderia AlphaTauri Honda
22	Yuki Tsunoda	Japan	Scuderia AlphaTauri Honda
23	Alexander Albon	Thailand	Williams Racing
2	Logan Sargeant	USA	Williams Racing



3. 2023 FIA FORMULA 1 WORLD CHAMPIONSHIP™

3.3 STATISTICAL DATA

2023 POLE POSITION/WINNER/FASTEST LAP

GP	POLE POSITION	WINNER	FASTEST LAP
Bahrain	Max Verstappen	Max Verstappen	Zhou Guanyu
Saudi Arabia	Sergio Perez	Sergio Perez	Max Verstappen
Australia	Max Verstappen	Max Verstappen	Sergio Perez
Azerbaijan	Charles Leclerc	Sergio Perez	George Russell

3. 2023 FIA FORMULA 1 WORLD CHAMPIONSHIP™

3.3 STATISTICAL DATA CONT...

2023 DRIVERS STANDING TO DATE

DRIVER	BAH	SAU	AUS	AZE	TOTAL
Max Verstappen	25	19	25	24	93
Sergio Perez	18	25	11	33	87
Fernando Alonso	15	15	15	15	60
Lewis Hamilton	10	10	18	10	48
Carlos Sainz	12	8	0	14	34
Charles Leclerc	0	6	0	22	28
George Russell	6	12	0	10	28
Lance Stroll	8	0	12	7	27
Lando Norris	0	0	8	2	10
Nico Hulkenberg	0	0	6	0	6
Oscar Piastri	0	0	4	0	4
Valtteri Bottas	4	0	0	0	4
Esteban Ocon	0	4	0	0	4
Pierre Gasly	2	2	0	0	4
Zhou Guanyu	0	0	2	0	2
Yuki Tsunoda	0	0	1	1	2
Alexander Albon	1	0	0	0	1
Kevin Magnussen	0	1	0	0	1
Logan Sargeant	0	0	0	0	0
Nyck de Vries	0	0	0	0	0

3. 2023 FIA FORMULA 1 WORLD CHAMPIONSHIP™

3.3 STATISTICAL DATA CONT...

2023 TEAM STANDING TO DATE

CONSTRUCTOR	BAH	SAU	AUS	AZE	TOTAL
Oracle Red Bull Racing	43	44	36	57	180
Aston Martin Aramco Cognizant Formula 1 Team	23	15	27	22	87
Mercedes-AMG Petronas F1 Team	16	22	18	20	76
Scuderia Ferrari	12	14	0	36	62
McLaren F1 Team	0	0	12	2	14
BWT Alpine F1 Team	2	6	0	0	8
Moneygram Haas F1 Team	0	1	6	0	7
Alfa Romeo F1 Team Stake	4	0	2	0	6
Scuderia AlphaTauri	0	0	1	1	2
Williams Racing	1	0	0	0	1

3. 2023 FIA FORMULA 1 WORLD CHAMPIONSHIP™ - RULES & REGULATIONS

3.4 REVOLUTIONARY CHANGES IN FORMULA 1 IN 2023*

Following last season's revolutionary changes the 10 rule changes for the 2023 season include technical and sporting changes from cutting curfews to grid penalties:

1. Ride height and diffusers adjusted

With some teams encountering porpoising upon the arrival of F1's new-spec cars last year, which feature ground-effect aerodynamics, a set of floor-based flexibility and monitoring measures arrived for the second half of the 2022 season, and more have been outlined for 2023.

In short, four additional changes will come into play this year: floor edges have been raised by 15mm; the diffuser throat height has been raised; the diffuser edge stiffness has been increased; and an additional sensor has been mandated to more effectively monitor the porpoising phenomenon.

These adjustments should, in theory, make significant porpoising a thing of the past and, as such, keep the focus on the thrilling action that F1's rules reset has delivered.

2. Stronger roll hoops after Zhou's crash

Alongside the changes aimed at porpoising, there are tweaks to the safety standards for F1 car roll hoops after the frightening crash experienced by Zhou Guanyu at the start of the 2022 British Grand Prix, which involved his Alfa Romeo sliding along the track upside down.

The 2023 Technical Regulations now state that a rounded top is required on the roll hoop, which will reduce the chance of it digging into the ground during an accident, while they also ensure a minimum height for the point of application of the homologation test.

Additionally, there will be a new physical homologation test where the load pushes the roll hoop in a forward direction.

3. Revised mirrors to improve driver visibility

In an attempt to increase driver visibility, there will be a change to rear-view mirrors on F1's 2023-spec cars, with the width of the reflective surface increasing by 50mm from 150mm to 200mm.

Following tests by Red Bull and Mercedes in Hungary and Belgium respectively last season, the entire grid got involved at the Dutch Grand Prix, and the changes have now been written into the regulations.

4. Double the number of Sprint events

An exciting development for 2023 sees the number of Sprint events doubled from three to six. Azerbaijan (Baku), Austria (Red Bull Ring), Belgium (Spa-Francorchamps), Qatar (Lusail), the United States (Circuit of The Americas) and Sao Paulo (Interlagos) are the venues chosen, following on from extensive research into their suitability. Meanwhile, Sprint accident damage allowance will now be a fixed amount per team, for each race weekend that includes a Sprint session. The forfeit allowance amount for each Sprint will double to \$300k from 2023 onwards, while all other Sprint damage allowances will be removed.

Alongside this, parc ferme rules on Sprint weekends are under review for 2023, with the aim of simplifying the set-up-locking process, after the FIA cited a "significant increase in parc ferme requests" between Friday's qualifying session and Saturday's Sprint.

3. 2023 FIA FORMULA 1 WORLD CHAMPIONSHIP™ - RULES & REGULATIONS

3.4 REVOLUTIONARY CHANGES IN FORMULA 1 IN 2023*

5. Paddock working hours cut

The number of hours worked by F1 team members across race weekends will be reduced in upcoming seasons, with the third of three restricted periods (effective on Fridays) beginning an hour earlier this year, and another hour set to be knocked off in 2024.

To complement the move, the number of curfews permitted for the first (Wednesday) and second (Thursday) restricted periods will also be cut in half, from eight to four and six to three respectively, again with another cut planned for next year.

6. Qualifying format and DRS trials

A 'Revised Qualifying Format' (RQF) will take place at up to two events in 2023 "for the purpose of evaluating whether the revisions are suitable for subsequent championships" - as per the updated regulations.

This will see tyre compounds mandated for each stage of F1's usual three-part qualifying session: hard tyres only in Q1; mediums tyres only in Q2; and, finally, soft tyres only in Q3. Intermediates and wets will be allowed if the RQF sessions are declared wet.

At RQF events, each driver may use no more than 11 sets of dry-weather tyres, four sets of intermediate tyres and three sets of wet-weather tyres. This compares to the normal weekend allowance of 13 sets of dry-weather tyres, four sets of intermediate tyres and three sets of wet-weather tyres.

As for DRS, its activation after the start, race restart or Safety Car restart will also be evaluated, with the F1 Commission exploring the possibility of bringing this forward by one lap at the start of a race or Sprint or Safety Car restart.

"This will be trialled during each Sprint session in 2023 with a view to introducing it for all races in 2024," the FIA have stated.

7. Tweaks around gearbox changes

While changes to teams' homologated gearboxes were only previously permitted "to resolve reliability problems" or "for cost saving, at the start of each season", modifications are now permitted "in the case of materials, processes or proprietary parts becoming unavailable".

Nonetheless, clear documentation justifying the change must be provided in all cases, prior approval must be obtained from the FIA, and the modification must not give any performance advantage. A summary of the modification will then be circulated to all teams by the FIA.

8. A move to clear up penalty confusion

Grid penalties came under the spotlight at last year's Italian Grand Prix, where a host of drivers took power unit and gearbox related drops and turned the order on its head. Following some confusion over how these were applied, the wording of the regulations has been updated.

The relevant section now reads: "Classified drivers who have accrued more than 15 cumulative grid position penalties, or who have been penalised to start at the back of

3. 2023 FIA FORMULA 1 WORLD CHAMPIONSHIP™ - RULES & REGULATIONS

3.4 REVOLUTIONARY CHANGES IN FORMULA 1 IN 2023*

the grid, will start behind any other classified driver. Their relative position will be determined in accordance with their qualifying classification.”

9. More flexibility to cool fuel

A small change on paper could have an impact on reliability in 2023, particularly at hotter races, with some extra freedom being given to teams regarding the cooling of fuel.

For 2023, fuel in a car must not be colder than the lowest of either 10 degrees centigrade below ambient temperature, or 10 degrees centigrade (this being cut from 20 degrees), at any time when the car is running after leaving the competitor’s designated garage area.

*Formula.com

3. 2023 FIA FORMULA 1 WORLD CHAMPIONSHIP™

3.5 POINTS & CLASSIFICATION

Points & Classification - The top ten finishers in each Grand Prix score points towards both the drivers' and the constructors' world championships, according to the following scale:

Position	1st	2nd	3rd	4th	5th	6th	7th	8th	9th	10th
Points	25	18	15	12	10	8	6	4	2	1

Bonus points

The driver who records the fastest lap of the race will get one bonus point. However, the driver must also finish in the top 10 in order to qualify for the point. This is to stop all the drivers outside the top 10 pitting for fresh tyres in the last few laps in an effort to set a fastest lap, which would compromise the integrity of the race.

Sprint Events

Formula 1 introduces six F1 Sprint events, with the number of events doubling from three staged in 2021 and 2022.

F1 Sprint sees the standard one-hour qualifying session shifted to Friday, setting the grid for a 100-kilometre dash on Saturday, which in turn sorts the starting order for Sunday's main event.

Next year, the Sprints will be held in Azerbaijan (Baku City Circuit), Austria (Red Bull Ring), Belgium (Spa-Francorchamps), Qatar (Lusail Circuit), the United States (Circuit of The Americas) and Sao Paulo (Interlagos).

Interlagos continues as a Sprint venue after playing host in 2021 and 2022, while the Red Bull Ring also featured the revised format last season. Silverstone, Monza and Imola are the other venues to have hosted Sprints in the past.

The 2023 selection came following research into the most suitable tracks for the format, including overtaking opportunities, close racing and high-speed sections - and is designed to ensure competitive on-track action across all three days of the selected Grand Prix weekends.

F1's financial regulations have also been tweaked, as the sport's governing body the FIA announced the teams' cost cap allowance for each Sprint will double from next year onwards, from \$150,000 to \$300,000 - though there will no longer be any further allowance for accident damage sustained in the Sprint events.

Formula 1 President and CEO Stefano Domenicali welcomed the increase from three to six events for next year.

"We have seen a hugely positive reaction to the F1 Sprint events during the first two years of its running, and we can't wait to bring even more action to fans with six events next year, including our first US F1 Sprint in Austin," he said.

"The introduction of the F1 Sprint has created a race weekend that includes three days of competitive racing action and brings more entertainment to fans of the sport as well as additional value for key stakeholders including teams, broadcasters, partners, and host venues."



3. 2023 FIA FORMULA 1 WORLD CHAMPIONSHIP™

3.5 POINTS & CLASSIFICATION

Mohammed Ben Sulayem, President of the FIA added: "Following strong collaboration between the FIA and FOM, and the approval of the World Motor Sport Council, we are pleased to reveal the six events for Sprints for the 2023 season. We look forward to this exciting addition to the calendar."

Grand Prix	Circuit	Date
Azerbaijan	Baku City Circuit	April 28 - 30
Austria	Red Bull Ring	June 30 - July 2
Belgium	Spa-Francorchamps	July 28 - 30
Qatar	Lusail Circuit	October 06 - 08
United States	Circuit of The Americas	October 20 - 22
Sao Paulo	Interlagos	November 3 -5

*Formula.com

4. 2023 FIA FORMULA 1 WORLD CHAMPIONSHIP™ - TEAM INFORMATION

ORACLE RED BULL RACING



Headquarters	Bradbourne Drive Tilbrook Milton Keynes MK7 8BJ, England	Telephone Fax Website	+44 (0)1908 279700 +44 (0)1908 279810 www.redbullracing.com
---------------------	---	--	---

Team Principal	Christian Horner OBE	Chief Engineering Officer	Pierre Wache
Chief Technical Officer	Adrian Newey OBE	Chief Engineer, Car Engineering	Paul Monaghan
Technical Director	Jonathan Wheatley	Head of Aerodynamics	Ben Waterhouse

Media Contacts:

Head of Communications	Paul Smith Mob: +44 (0) 7769 288 044; Email: paul.smith@redbulltechnology.com
-------------------------------	--

Communications Managers	Gemma Lusty Mob: +44 (0)7801 888317; Email: Gemma.Lusty@redbullracing.com
--------------------------------	--

	Alice Hedworth Mob: +44 (0)7709 514098; Email: alice.hedworth@redbullracing.com
--	--

Formula 1 Debut	2005	Chassis	RB19
Constructors' Titles	5	Power Unit	Red Bull Powertrains
GP Starts	351		
GP Wins	96		
Fastest Laps	86		
Pole Positions	84	Total Points	6568

MAX VERSTAPPEN
1



SERGIO PEREZ
11



Date of Birth	30/09/1997
Formula 1 Debut	2014
GP Starts	167
GP Wins	37
Pole Positions	22
Podiums	81
F1 Titles	1
Total F1 Points	2104.5

Date of Birth	26/01/1990
Formula 1 Debut	2011
GP Starts	239
GP Wins	6
Pole Positions	2
Podiums	29
F1 Titles	N/A
Total F1 Points	1288

SCUDERIA FERRARI



Headquarters	Ferrari S.p.A. Via Ascari 55-57 41053 Maranello Italy	Telephone	+39 536 949 111
		Fax	+39 536 949 049
		Website	www.formula1.ferrari.com

Team Principal	Frederic Vasseur	Head of Chassis Area	Enrico Cardile
Racing Director	Laurent Mekies	Head of Power Unit Area	Enrico Gualtieri

Media Contact:

Head of Motorsport Press Office Silvia Hoffer Frangipane
Mob: +39 344 0556 635 Email: Silvia.Hoffer@ferrari.com

Formula 1 Debut	1950	Chassis	SF-23
Constructors' Titles	16	Power unit	Ferrari
GP Starts	1058		
GP Wins	242		
Fastest Lap	259		
Pole Positions	244	Total Points	9004



CHARLES LECLERC

16



Date of Birth	16/10/1997
Formula 1 Debut	2018
GP Starts	106
GP Wins	4
Pole Positions	19
Podiums	25
F1 Titles	N/A
Total F1 Points	896



CARLOS SAINZ

55



Date of Birth	01/09/1994
Formula 1 Debut	2015
GP Starts	166
GP Wins	1
Pole Positions	3
Podiums	15
F1 Titles	N/A
Total F1 Points	816.5

MERCEDES-AMG PETRONAS F1 TEAM



Headquarters	Operations Centre Brackley NN13 7BD, UK	Phone Fax Website	+44 (0)1280 844 000 +44 (0) 1280 844 001 www.mercedesAMGF1.com
---------------------	---	--	--

Team Principal & CEO Toto Wolff

MD of Mercedes AMG High Performance Powertrains Hvwel Thomas

Chief Operating Officer James Allison

Technical Director Mike Elliott

Chief Technical Officer James Allison

Media Contacts:

Communications Director Bradley Lord; Mob: + 44 (0)7785 682 893
Email: blord@mercedesamgf1.com

Senior Media Manager Adam McDaid; Mob: + 44 (0)7918 335 332
Email: amcdaid@mercedesamgf1.com

Senior Public Relations Manager Rosa Herrero Venegas ; Mob: +44 7469 353 191
Email: rherrerovenegas@mercedesamgf1.com

Formula 1 Debut	1954	Chassis	Mercedes-AMG F1 W13 E Performance
Constructors' Titles	8	Power Unit	Mercedes-AMG F1 M13 E Performance
GP Starts	275		1.6-Litre V6
GP Wins	125		
Fastest Laps	101		
Pole Positions	128	Total Points	6889.5



LEWIS HAMILTON
44



Date of Birth	07/01/1985
Formula 1 Debut	2007
GP Starts	314
GP Wins	103
Pole Positions	103
Podiums	192
F1 Titles	7
Total F1 Points	4453.5



GEORGE RUSSELL
63



Date of Birth	15/02/1998
Formula 1 Debut	2019
GP Starts	86
GP Wins	1
Pole Positions	1
Podiums	9
F1 Titles	N/A
Total F1 Points	322

BWT ALPINE F1 TEAM



Headquarters	Whiteways Technical Centre Enstone OX7 4EE, England	Telephone	+44 (0)1608 678 000
		Fax	+44 (0)1608 678 609
		Website	www.alpinecars.com

CEO	Laurent Rossi	Team Principal	Otmar Szafnauer
------------	---------------	-----------------------	-----------------

Chassis Technical Director	Pat Fry	Technical Director	Matt Harman
-----------------------------------	---------	---------------------------	-------------

Media Contacts

Head of Communications	Mario Almeida Mob +44 7423 483430; mario.almeida@uk.alpineracing.com
-------------------------------	--

Media Communications Manager	Clarisse Hoffmann Mob +44 7747 468273; clarisse.hoffmann@uk.alpineracing.com
-------------------------------------	--

Press Officer	James Lloyd Mob +44 7827 879601; james.lloyd@uk.alpineracing.com
----------------------	--

Formula 1 Debut	2021	Chassis	A523
Constructors' Titles	N/A	Power Unit	RBPT Honda
GP Starts	48		
GP Wins	1		
Fastest Laps	0		
Pole Positions	0	Total Points	336



PIERRE GASLY
10



ESTEBAN OCON
31

Date of Birth	07/02/1996
Formula 1 Debut	2017
GP Starts	112
GP Wins	1
Pole Positions	0
Podiums	3
F1 Titles	N/A
Total F1 Points	336

Date of Birth	17/09/1996
Formula 1 Debut	2016
GP Starts	115
GP Wins	1
Pole Positions	N/A
Podiums	2
F1 Titles	N/A
Total F1 Points	368

McLAREN F1 TEAM



Headquarters	McLaren Technology Centre Chertsey Road Woking, Surrey GU21 4YH, England	Telephone	+44 (0) 1483 261 900
		Fax	+44 (0) 1483 261 902
		Website	www.mclaren.com
Chief Executive Officer		Zak Brown	
Team Principal		Andrea Stella	
Technical Director		David Sanchez	
Media Contacts			
Communications Director		Sophie Ogg; Mob: +44(0)7787 250393 Email: sophie.ogg@mclaren.com	
Communications Specialist		Harry Bull; Mob: +44(0)7388 961954 Email: harry.bull@mclaren.com	
Communications Executive		Sophie Almeida; Mob: +44(0)799 041442 Email: sophie.almeida@mclaren.com	
Formula 1 Debut	1966	Chassis	MCL60
Constructors' Titles	8	Power Unit	Mercedes-AMG F1 M14 E Performance
GP Starts	932		
GP Wins	183		
Fastest Laps	162		
Pole Positions	156	Total Points	6003.5



LANDO NORRIS
04



Date of Birth	13/11/1999
Formula 1 Debut	2019
GP Starts	86
GP Wins	N/A
Pole Positions	1
Podiums	6
F1 Titles	N/A
Total F1 Points	438

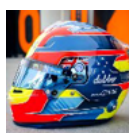

OSCAR PIASTR
81



Date of Birth	06/04/2001
Formula 1 Debut	2023
GP Starts	4
GP Wins	N/A
Pole Positions	N/A
Podiums	N/A
F1 Titles	N/A
Total F1 Points	4



ALFA ROMEO F1 TEAM STAKE



Headquarters	Wildbachstrasse 9 8340 Hinwil Switzerland	Telephone	+41 44 973 9000
		Fax	+44 44 973 9001
		Website	www.sauber-group.com

Team Representative Alessandro Alunni Bravi

Technical Director Jan Monchaux

Media Contacts

Senior Communications Manager Will Ponissi; Mob: +41 79 591 57 85
Email: William.Ponissi@sauber-group.com

Communications Manager Katharina Rees; Mob: +41 44937 96 76; Katharina.Rees@sauber-group.com
Elena Rovelli; Mob: +41 78209 18 57; elena.rovelli@sauber-group.com

Formula 1 Debut	1993	Chassis	C43
Constructors' Titles	N/A	Power Unit	Ferrari 066/10
GP Starts	196		
GP Wins	10		
Podiums	26		
Fastest Laps	16		
Pole Positions	12	Total Points	189

VALTTERI BOTTAS
77



Date of Birth	28/08/1989
Formula 1 Debut	2013
GP Starts	204
GP Wins	10
Pole Positions	20
Podiums	67
F1 Titles	N/A
Total F1 Points	1791

ZHOU GUANYU
24



Date of Birth	30/05/1999
Formula 1 Debut	2022
GP Starts	26
GP Wins	N/A
Pole Positions	N/A
Podiums	N/A
F1 Titles	N/A
Total F1 Points	8

**ASTON MARTIN ARAMCO COGNIZANT
FORMULA ONE™ TEAM**



Headquarters	Dadford Road Silverstone NN12 8TJ England	Telephone Fax Website	+44 (0)1327 850 800 +44 (0)1327 857 993 www.astonmartinf1.com
---------------------	--	--	---

Executive Chairman	Lawrence Stroll	Team Principal	Mike Krack
---------------------------	-----------------	-----------------------	------------

Chief Technical Officer Dan Fallows

Media Contacts

Head of Communications & Media	Will Hings Mob: +44 (0)7734 202020 Email: will.hings@astonmartinf1.com
---	---

Senior Partner Comms Manager	Steve Cooper Mob: +44 (0)7734 202020 Email: will.hings@astonmartinf1.com
-------------------------------------	---

Communications & Media Officer	Eve Merrell Mob: +44 (0)7408 833295 Email: eve.merrell@astonmartinf1.com
---	--

	Michael Clayton Mob: +44 (0)7408 808814 Email: michael.clayton@astonmartinf1.com
--	--

Formula 1 Debut	1959	Chassis	AMR22
Constructors' Titles	N/A	Power Unit	Mercedes
GP Starts	53		
GP Wins	0		
Podiums	4		
Fastest Laps	N/A		
Pole Positions	0	Total Points	219

FERNANDO ALONSO
14

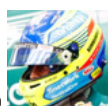

Date of Birth	29/07/1981
Formula 1 Debut	2001
GP Starts	359
GP Wins	32
Pole Positions	22
Podiums	101
F1 Titles	2
Total F1 Points	2121

LANCE STROLL
18



Date of Birth	29/10/1998
Formula 1 Debut	2017
GP Starts	126
GP Wins	N/A
Pole Positions	1
Podiums	3
F1 Titles	N/A
Total F1 Points	221

Promoter
South Florida Motorsports

Website: <https://f1miamigp.com/>

SCUDERIA ALPHATAURI



Headquarters Via Boaria, 229
48018 Faenza RA
Italy

Telephone +39 (0)546 696 111
Fax +39 (0)546 620 998
Website www.scuderiazalphatauri.com

Team Principal Franz Tost **Team Manager** Marco Perrone

Technical Director Jody Egginton

Media Contacts

Head of Communications Fabiana Valenti
Mob: +39 335 7113 694 Email: fabiana.valenti@scuderiazalphatauri.com

Press Officers Jana Gattereder
Mob: +39 366 6589844 Email: jana.gattereder@scuderiazalphatauri.com

Andrea Saveri
Mob: +39 366 6578600 Email: andrea.saveri@scuderiazalphatauri.com

Formula 1 Debut	2006	Chassis	AT04
Constructors' Titles	N/A	Power Unit	RBPT Honda
GP Starts	333		
GP Wins	2		
Podiums	5		
Fastest Laps	2		
Pole Positions	1	Total Points	786

YUKI TSUNODA
22

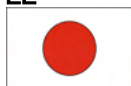

NYCK DE VRIES
21



Date of Birth 11/05/2000
Formula 1 Debut 2021
GP Starts 46
GP Wins N/A
Pole Positions N/A
Podiums N/A
F1 Titles N/A
Total F1 Points 46

Date of Birth 06/02/1995
Formula 1 Debut 2022
GP Starts 5
GP Wins N/A
Pole Positions N/A
Podiums N/A
F1 Titles N/A
Total F1 Points 2



WILLIAMS RACING

WILLIAMS RACING

Headquarters	Grove, Wantage Oxfordshire OX12 0DQ England	Telephone	+44 (0)1235 777 700
		Fax	+44 (0)1235 777 960
		Website	www.williamsf1.com
Team Principal	James Vowles	Sporting Director	Sven Smeets

Media Contacts:

Communications Lead Rebecca Banks
Email: Rebecca.Banks@williamsf1.com

Senior Press Officers Dominique Heyer-Wright
Email: d.heyerwright@williamsf1.com

Connor Bean
Email: connor.bean@williamsf1.com

Formula 1 Debut	1977	Chassis	FW45
Constructors' Titles	9	Power Unit	Mercedes F1 M14 E Performance
GP Starts	792		
GP Wins	114		
Podiums	312		
Fastest Laps	133		
Pole Positions	128	Total Points	3431

ALEXANDER ALBON
23



LOGAN SARGEANT
02



Date of Birth	23/03/1996
Formula 1 Debut	2019
GP Starts	63
GP Wins	N/A
Pole Positions	N/A
Podiums	2
F1 Titles	N/A
Total F1 Points	202

Date of Birth	21/12/2001
Formula 1 Debut	2023
GP Starts	4
GP Wins	N/A
Pole Positions	N/A
Podiums	N/A
F1 Titles	N/A
Total F1 Points	0



MONEYGRAM HAAS F1 TEAM



Headquarters	UK/Haas F1 Team Overthorpe Road Banbury OX16 4PN	Telephone	+ 44 (0)1295 262455
		Website	www.haasf1team.com
Team Principal	Guenther Steiner	Chief Operating Officer	Joe Custer
Technical Director	Simone Resta		

Media Contacts

Head of Communications Stuart Morrison
Mob: +44 7779 773466 Email: smorrison@haasf1team.com

Formula 1 Debut	2016	Chassis	Haas VF-23
Constructors' Titles	N/A	Power Unit	Ferrari
GP Starts	148		
GP Wins	N/A		
Podiums	N/A		
Fastest Laps	2		
Pole Positions	N/A	Total Points	244

KEVIN MAGNUSSEN
47



NICO HULKENBERG
27



Date of Birth 05/10/1992
Formula 1 Debut 2014
GP Starts 145
GP Wins N/A
Pole Positions N/A
Podiums 1
F1 Titles N/A
Total F1 Points 184

Date of Birth 19/08/1987
Formula 1 Debut 2010
GP Starts 185
GP Wins N/A
Pole Positions 1
Podiums N/A
F1 Titles N/A
Total F1 Points 527

5. 2023 FIA FORMULA 1 WORLD CHAMPIONSHIP™ CIRCUIT CHARACTERISTICS

FORMULA 1 GULF AIR SAHARA GRAND PRIX 2023 SAHIR

Date	03 - 05 March	Race distance	308.238 km
Circuit length	5.412 km	Number of laps	57

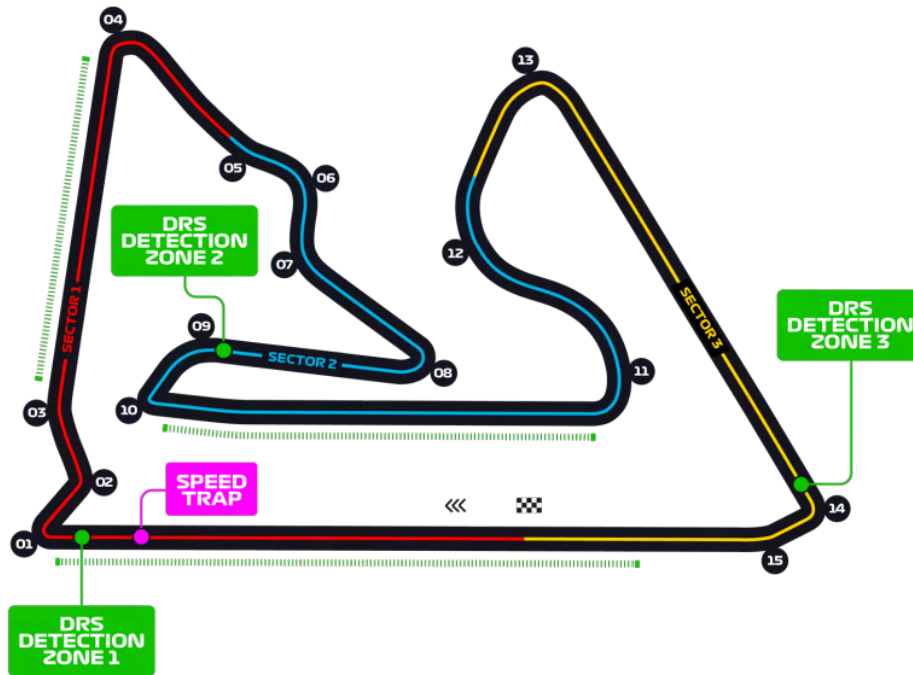

The Bahrain International Circuit has established itself as a popular host for world-class motor sport. Professional facilities and experienced staff have paved the way for numerous international race series to utilize the circuit, including Formula 2/ Formula 3 Championship and Porsche Sprint Challenge Middle East.

You can usually expect great racing and decent amounts of overtaking in Bahrain, while the drivers have to contend with wind, racing under floodlights and the difficulty of finding a decent set-up with the wide temperature fluctuations between sessions. The track's most challenging point is the tight, downhill, off-camber Turn 10 left-hander, while the fast run through Turn 12 is another highlight, allowing the racers to really feel their cars coming alive.

FORMULA 1 GULF AIR BAHRAIN GRAND PRIX 2023

RESULTS

Pos	Driver	Team	Time / Retired	Grid
1	Max Verstappen	Oracle Red Bull Racing	1:33:56.736	1
2	Sergio Perez	Oracle Red Bull Racing	+11.987s	2
3	Fernando Alonso	Aston Martin Aramco Cognizant Formula 1 Team	+38.637s	5
4	Carlos Sainz	Scuderia Ferrari	+48.052s	4
5	Lewis Hamilton	Mercedes-AMG Petronas F1 Team	+50.977s	7
6	Lance Stroll	Aston Martin Aramco Cognizant Formula 1 Team	+54.502s	8
7	George Russell	Mercedes-AMG Petronas F1 Team	+55.873	6
8	Valtteri Bottas	Alfa Romeo F1 Team Stake	+72.647	12
9	Pierre Gasly	BWT Alpine F1 Team	+73.753	20
10	Alexander Albon	Williams Racing	+89.774	15
11	Yuki Tsunoda	Scuderia AlphaTauri	+90.870	14
12	Logan Sargeant	Williams Racing	+1 lap	16
13	Kevin Magnussen	Moneygram Haas F1 Team	+1 lap	17
14	Nyck De Vries	Scuderia AlphaTauri	+1 lap	19
15	Nico Hulkenberg	Moneygram Haas F1 Team	+1 lap	10
16	Zhou Guanyu	Alfa Romeo F1 Team Stake	+1 lap	13
17	Lando Norris	McLaren F1 Team	+2 laps	11
NC	Esteban Ocon	BWT Alpine F1 Team	DNF	9
NC	Charles Leclerc	Scuderia Ferrari	DNF	3
NC	Oscar Piastri	McLaren F1 Team	DNF	18
Pole position		Max Verstappen	1:29.708s	
Fastest lap		Zhou Guanyu	1:33.996s	

FORMULA 1 STC SAUDI ARABIAN GRAND PRIX 2023 JEDDAH

Date	17-19 March	Race distance	308.45 km
Circuit length	6.174 km	Number of laps	50

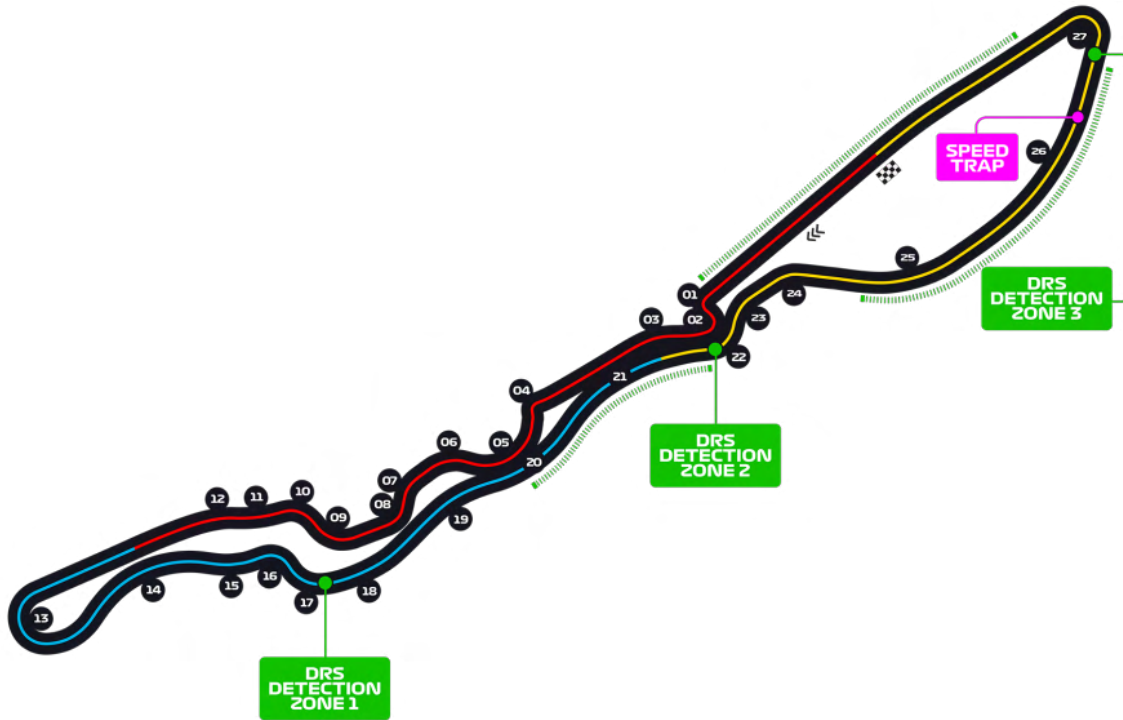

The return of F1 to Jeddah will be third time in less than 16 months that the pinnacle of motorsport will race on the world's fastest and longest street circuit since the inaugural Saudi Arabian Grand Prix took place in 2021. The race joining its Middle Eastern counterparts in Bahrain and Abu Dhabi - while like those races, the Saudi Arabian Grand Prix also takes place under floodlights.

The circuit is fast. Very fast. Average speeds around the Jeddah Corniche Circuit are around 250km/h - quicker than those at Silverstone, and second only to Monza - aka 'The Temple of Speed'. It is, quite simply, the fastest street circuit ever seen in Formula 1 - while the track also features the most corners on the calendar with 27, many of them quick, sinuous bends as the drivers wend their way along the Jeddah waterfront.

FORMULA 1 STC SAUDI ARABIAN GRAND PRIX 2023 RESULTS

Pos	Driver	Team	Time / Retired	Grid
1	Sergio Perez	Oracle Red Bull Racing	1:21:14.894	1
2	Max Verstappen	Oracle Red Bull Racing	+5.355s	15
3	Fernando Alonso	Aston Martin Aramco Cognizant Formula 1 Team	+20.728s	2
4	George Russell	Mercedes-AMG Petronas F1 Team	+25.866s	3
5	Lewis Hamilton	Mercedes-AMG Petronas F1 Team	+31.065s	7
6	Carlos Sainz	Scuderia Ferrari	+35.876s	4
7	Charles Leclerc	Scuderia Ferrari	+43.162s	12
8	Esteban Ocon	BWT Alpine F1 Team	+52.832s	6
9	Pierre Gasly	BWT Alpine F1 Team	+54.747s	9
10	Kevin Magnussen	Moneygram Haas F1 Team	+64.826s	13
11	Yuki Tsunoda	Scuderia AlphaTauri	+67.494s	16
12	Nico Hulkenberg	Moneygram Haas F1 Team	+70.588s	10
13	Zhou Guanyu	Alfa Romeo F1 Team Stake	+76.060s	11
14	Nyck De Vries	Scuderia AlphaTauri	+77.478s	18
15	Oscar Piastri	McLaren F1 Team	+85.021s	8
16	Logan Sargeant	Williams Racing	+86.293s	20
17	Lando Norris	McLaren F1 Team	+86.445s	19
18	Valtteri Bottas	Alfa Romeo F1 Team Stake	+1 lap	14
NC	Alexander Albon	Williams Racing	DNF	17
NC	Lance Stroll	Aston Martin Aramco Cognizant Formula 1 Team	DNF	5

Pole position	Sergio Perez	1:28.265s
Fastest lap	Max Verstappen	1:31.906s

**FORMULA 1 ROLEX AUSTRALIAN GRAND PRIX 2023
MELBOURNE**

Date	31 Mar - 02 Apr	Race distance	307.574 km
Circuit length	5.303 km	Number of laps	58

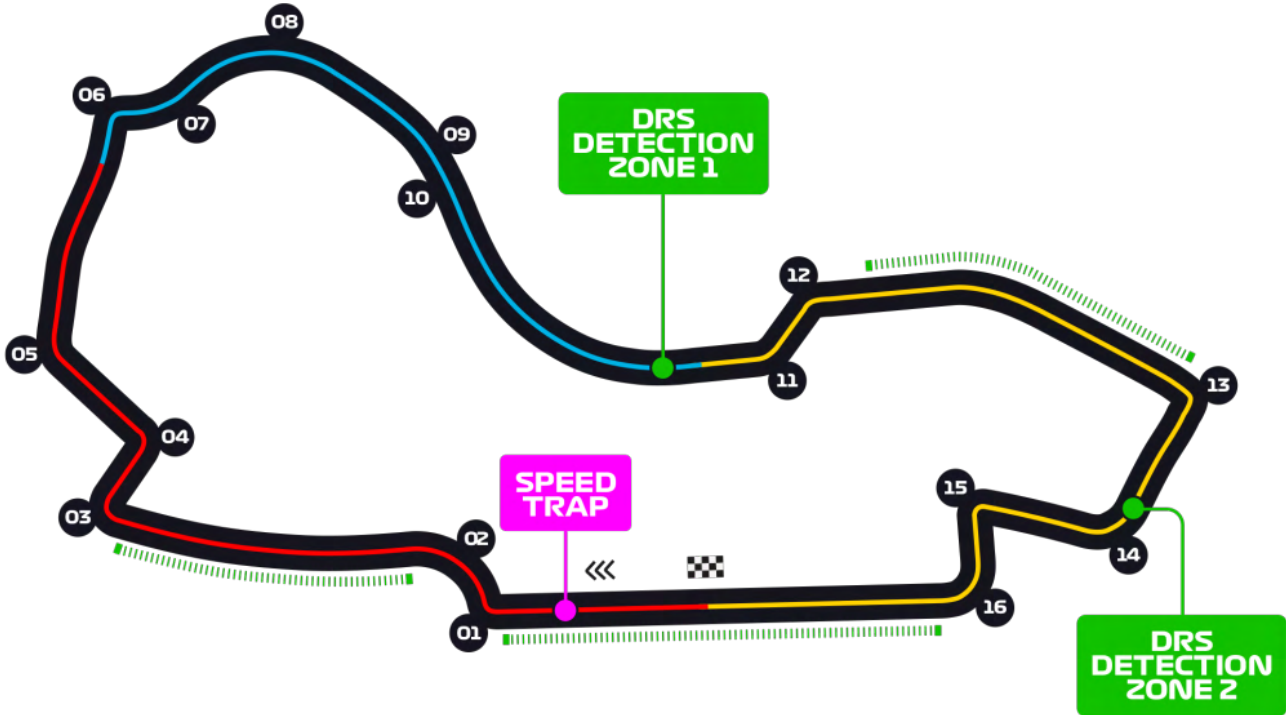

As a temporary facility, Albert Park can be quite bumpy, while the circuit at the start of the weekend is often slippery, rubbering in as the sessions progress. It's also a circuit that requires a well-sorted chassis, with several spots on the track where the drivers require a reactive front end to allow them to chuck it into a corner - the main one being the rapid Turn 11-12 chicane. Melbourne is also one of the faster tracks on the calendar, with Lewis Hamilton's 2019 pole lap set at an average of over 235km/h.

FORMULA 1 ROLEX AUSTRALIAN GRAND PRIX 2023 RESULTS

Pos	Driver	Team	Time / Retired	Grid
1	Max Verstappen	Oracle Red Bull Racing	2:32:38.371	1
2	Lewis Hamilton	Mercedes-AMG Petronas F1 Team	+0.179s	3
3	Fernando Alonso	Aston Martin Aramco Cognizant Formula 1 Team	+0.769s	4
4	Lance Stroll	Aston Martin Aramco Cognizant Formula 1 Team	+3.082s	6
5	Sergio Perez	Oracle Red Bull Racing	+3.320s	Pit
6	Lando Norris	McLaren F1 Team	+3.701s	13
7	Nico Hulkenberg	Moneygram Haas F1 Team	+4.939s	10
8	Oscar Piastri	McLaren F1 Team	+5.382s	16
9	Zhou Guanyu	Alfa Romeo F1 Team Stake	+5.713s	17
10	Yuki Tsunoda	Scuderia AlphaTauri	+6.052s	12
11	Valtteri Bottas	Alfa Romeo F1 Team Stake	+6.513s	Pit
12	Carlos Sainz	Scuderia Ferrari	+6.594s	5
13	Pierre Gasly	BWT Alpine F1 Team	DNF	9
14	Esteban Ocon	BWT Alpine F1 Team	DNF	11
15	Nyck De Vries	Scuderia AlphaTauri	DNF	15
16	Logan Sargeant	Williams Racing	DNF	18
17	Kevin Magnussen	Moneygram Haas F1 Team	DNF	14
NC	George Russell	Mercedes-AMG Petronas F1 Team	DNF	2
NC	Alexander Albon	Williams Racing	DNF	8
NC	Charles Leclerc	Scuderia Ferrari	DNF	7
Pole position		Max Verstappen	1:16.732s	
Fastest lap		Sergio Perez	1:20.235s	

**FORMULA 1 AZERBAIJAN GRAND PRIX 2023
BAKU**

Date	28 - 30 Apr	Race distance	306.049km
Circuit length	6.003 km	Number of laps	51

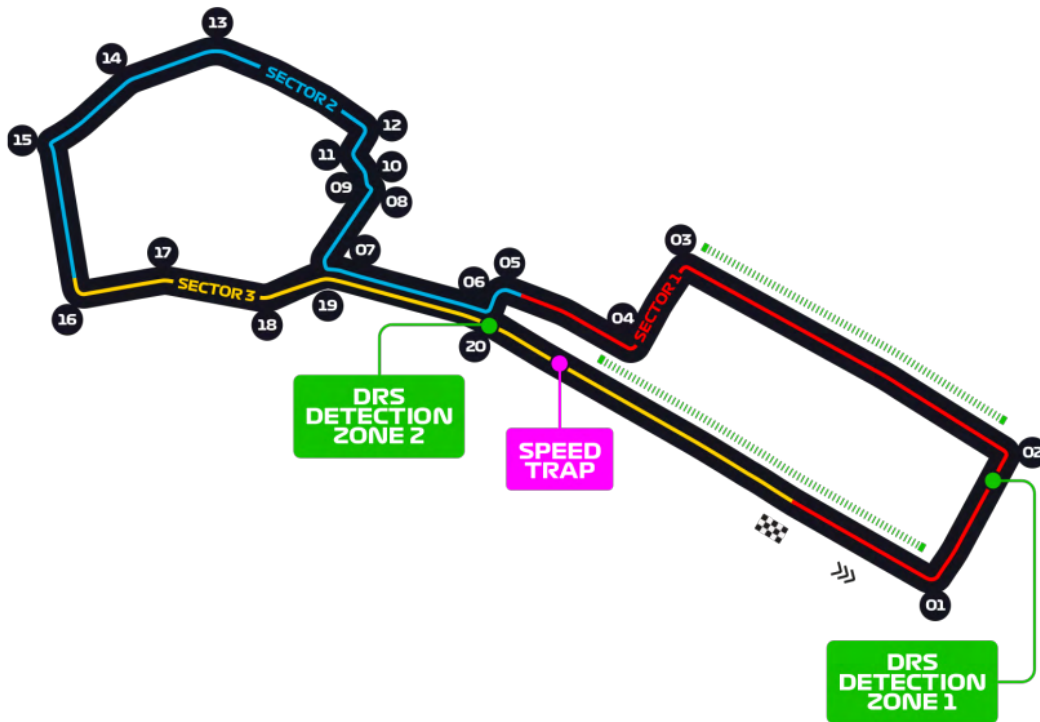

The six kilometre, anti-clockwise layout of the circuit offers a mixture of wide and open straights as well as tight and twisty corners. The circuit starts with a long main straight along the Baku shoreline, then loop around Government House before heading west to Maiden Tower. Here, the track has a narrow uphill traversal and then circle the Old Town before opening up onto a 2.2 km (1.4 mi) stretch along Neftchilar Avenue back to the start line.

FORMULA 1 AZERBAIJAN GRAND PRIX 2023

RESULTS : SPRINT RACE

Pos	Driver	Team	Time / Retired	Grid
1	Sergio Perez	Oracle Red Bull Racing	33:17.667	2
2	Charles Leclerc	Scuderia Ferrari	+4.463s	1
3	Max Verstappen	Oracle Red Bull Racing	+5.065s	3
4	George Russell	Mercedes-AMG Petronas F1 Team	+8.532s	4
5	Carlos Sainz	Scuderia Ferrari	+10.388s	5
6	Fernando Alonso	Aston Martin Aramco Cognizant Formula 1 Team	+11.613s	8
7	Lewis Hamilton	Mercedes-AMG Petronas F1 Team	+16.503s	6
8	Lance Stroll	Aston Martin Aramco Cognizant Formula 1 Team	+18.417s	9
9	Alexander Albon	Williams Racing	+21.757s	7
10	Oscar Piastri	McLaren F1 Team	+22.851s	11
11	Kevin Magnussen	Moneygram Haas F1 Team	+27.990s	13
12	Zhou Guanyu	Alfa Romeo F1 Team Stake	+34.602s	14
13	Pierre Gasly	BWT Alpine F1 Team	+36.918s	17
14	Nyck De Vries	Scuderia AlphaTauri	+41.626s	18
15	Nico Hulkenberg	Moneygram Haas F1 Team	+48.587s	12
16	Valtteri Bottas	Alfa Romeo F1 Team Stake	+49.917s	15
17	Lando Norris	McLaren F1 Team	+51.104s	10
18	Esteban Ocon	BWT Alpine F1 Team	+60.621s	Pit
NC	Yuki Tsunoda	Scuderia AlphaTauri	DNF	16
Pole position		Sergio Perez	33:17.667s	
Fastest lap		George Russell	1:43.370s	

FORMULA 1 AZERBAIJAN GRAND PRIX 2023

RESULTS : GRAND PRIX

Pos	Driver	Team	Time / Retired	Grid
1	Sergio Perez	Oracle Red Bull Racing	1:32:42.436	3
2	Max Verstappen	Oracle Red Bull Racing	+2.137s	2
3	Charles Leclerc	Scuderia Ferrari	+21.217s	1
45	Fernando Alonso	Aston Martin Aramco Cognizant Formula 1 Team	+22.024s	6
6	Carlos Sainz	Scuderia Ferrari	+45.491s	4
7	Lewis Hamilton	Mercedes-AMG Petronas F1 Team	+46.145s	5
8	Lance Stroll	Aston Martin Aramco Cognizant Formula 1 Team	+51.617s	9
9	George Russell	Mercedes-AMG Petronas F1 Team	+74.240s	11
10	Lando Norris	McLaren F1 Team	+80.376s	7
11	Yuki Tsunoda	Scuderia AlphaTauri	+83.862s	8
12	Oscar Piastri	McLaren F1 Team	+86.501s	10
13	Alexander Albon	Williams Racing	+88.623s	12
14	Kevin Magnussen	Moneygram Haas F1 Team	+89.729s	16
15	Pierre Gasly	BWT Alpine F1 Team	+91.332s	17
16	Esteban Ocon	BWT Alpine F1 Team	+97.794s	19
17	Logan Sargeant	Williams Racing	+100.943	14
18	Nico Hulkenberg	Moneygram Haas F1 Team	+1 lap	20
19	Valtteri Bottas	Alfa Romeo F1 Team Stake	+1 lap	13
NC	Zhou Guanyu	Alfa Romeo F1 Team Stake	DNF	15
NC	Nyck De Vries	Scuderia AlphaTauri	DNF	18
Pole position		Charles Leclerc	1:40.203s	
Fastest lap		George Russell	1:43.370s	

FORMULA 1 CRYPTO.COM MIAMI GRAND PRIX 2023 MIAMI

Date	05 - 07 May	Race distance	308.37 km
Circuit length	5.41 km	Number of laps	57

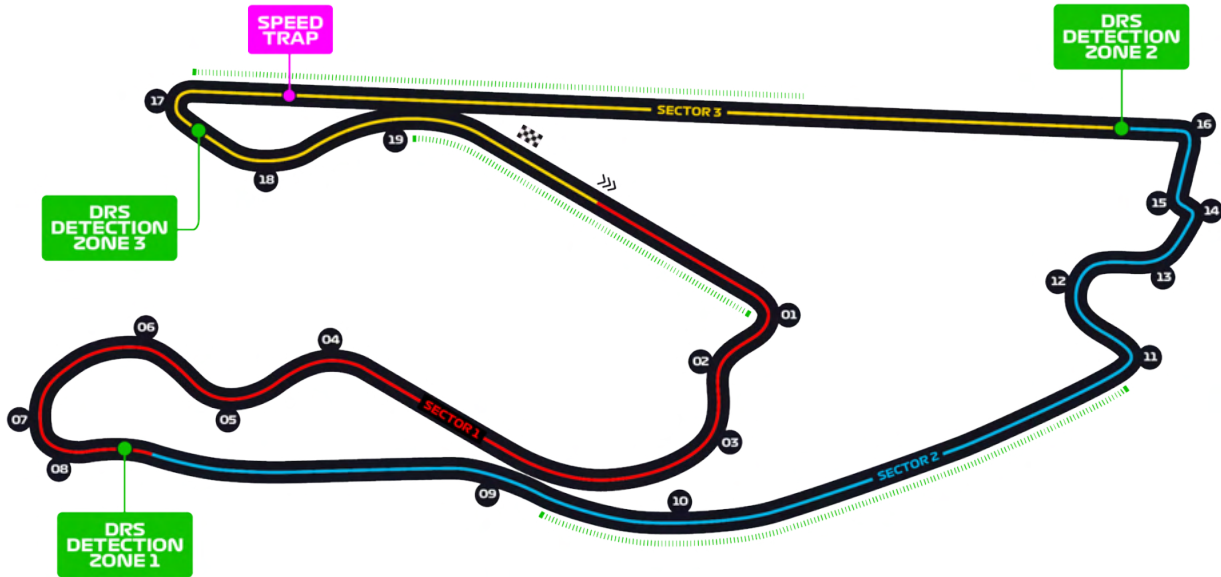

Having made its F1 debut in May 2022, the Miami International Autodrome is a temporary circuit, but one designed to have a permanent feel. Set in the Hard Rock Stadium complex in Miami Gardens, home to the NFL's famous Miami Dolphins franchise, the track is the culmination of a development process that simulated no less than 36 different layouts before settling on a thrilling, 19-turn lap that provides a street circuit vibe, not dissimilar to Melbourne's Albert Park.

The Florida race is one of three US races on the calendar alongside the Austin and Las Vegas Grand Prix.

FORMULA 1 QATAR AIRWAYS GRAN PREMIO DELL'EMILIA ROMAGNA 2023 IMOLA

Date	19 - 21 May	Race distance	309.049 km
Circuit length	4.909 km	Number of laps	63

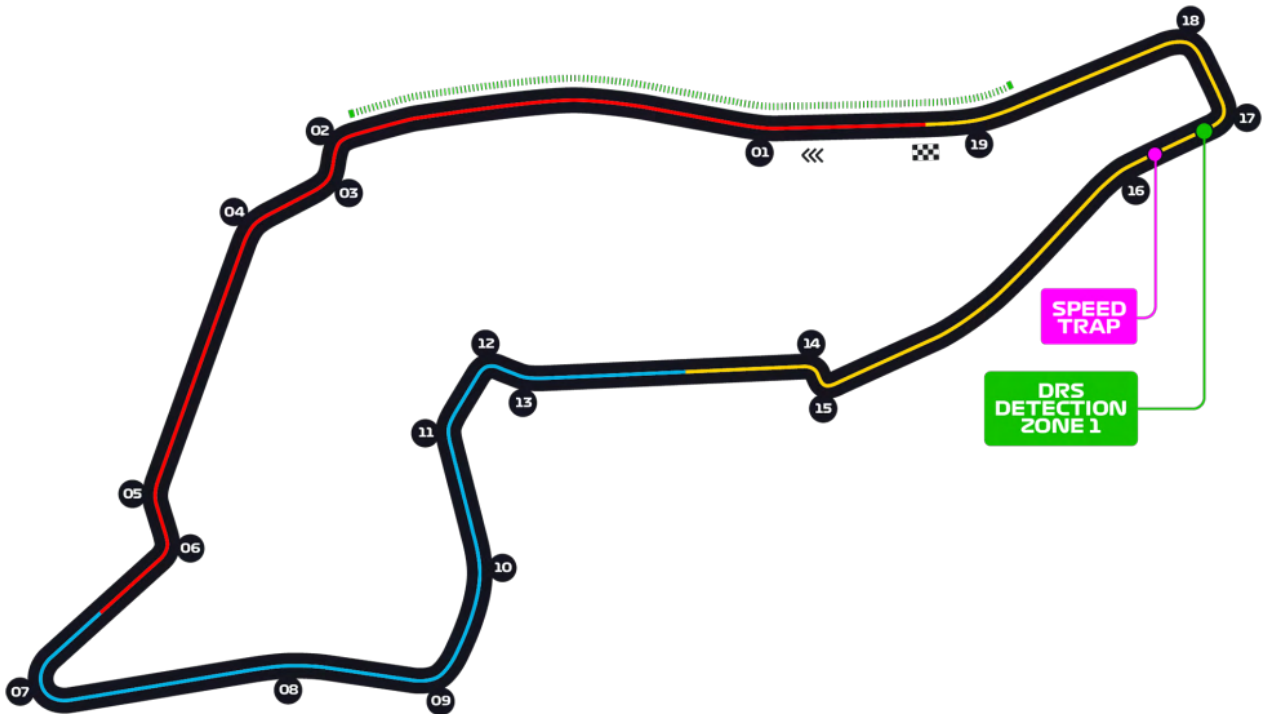

Imola had its foundation stone laid in March 1950. It was ready for testing by October 1952, while racing began at the circuit in 1953. The track was first awarded the honour of hosting the Italian Grand Prix in 1980. From 1981, Imola was taking on its famous 'San Marino' title and going on to host a total of 27 Grand Prix up until 2006. Imola returned to the F1 calendar amid the Covid-19 changes of 2020 and only recently signed a contract until 2025.

The circuit offers a thrill ride. After testing his AlphaTauri AT01 at the track in the build-up to the 2020 season, Pierre Gasly called the experience one of the best he'd ever had in a Formula 1 car, while his then-team mate Daniil Kvyat remarked that "an F1 car through corners like Acque Minerali - the entrance is so fast, it's so cool. It really gives you a lot of adrenaline." The anti-clockwise circuit is certainly fast, with an old-school feel as the drivers put it on the line in iconic corners like the aforementioned Acque Minerali and Piratella.

**FORMULA 1 GRAND PRIX DE MONACO 2023
MONTE CARLO**

Date	26 - 28 May	Race distance	260.286 km
Circuit length	3.337 km	Number of laps	78

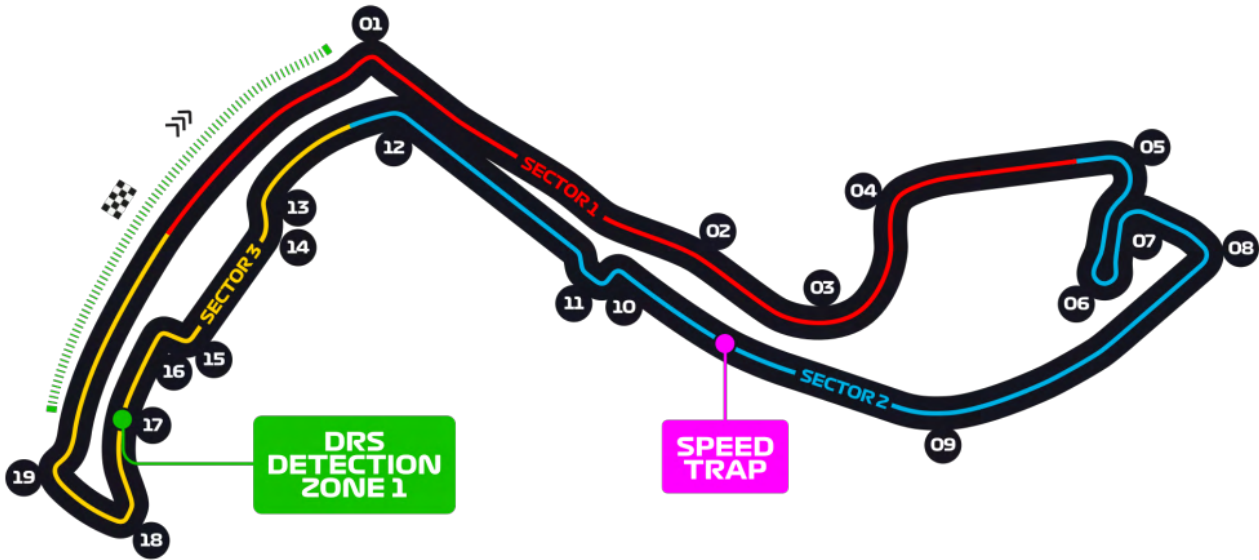

Monaco remains one of the most prestigious and iconic auto races in the world, long recognized for its entertainment and celebrity presence. It is a track nearly all drivers love, forcing them to put their skills on the line and rewarding millimetric accuracy. Overtaking on the tight streets is harder, however, with the 2003 Gran Prix witnessing a grand total of zero passing moves.

Motorsports most famous street circuit takes six weeks to build up and organize, offering drivers with the challenge of negotiating numerous elevations shifts and very tight corners, including one of the slowest corners in F1 racing as well as one of the fastest.

**FORMULA 1 AWS GRAN PREMIO DE ESPAÑA 2023
CIRCUIT DE BARCELONA-CATALUNYA**

Date	02 - 04 Jun	Race distance	308.424 km
Circuit length	4.675 km	Number of laps	66

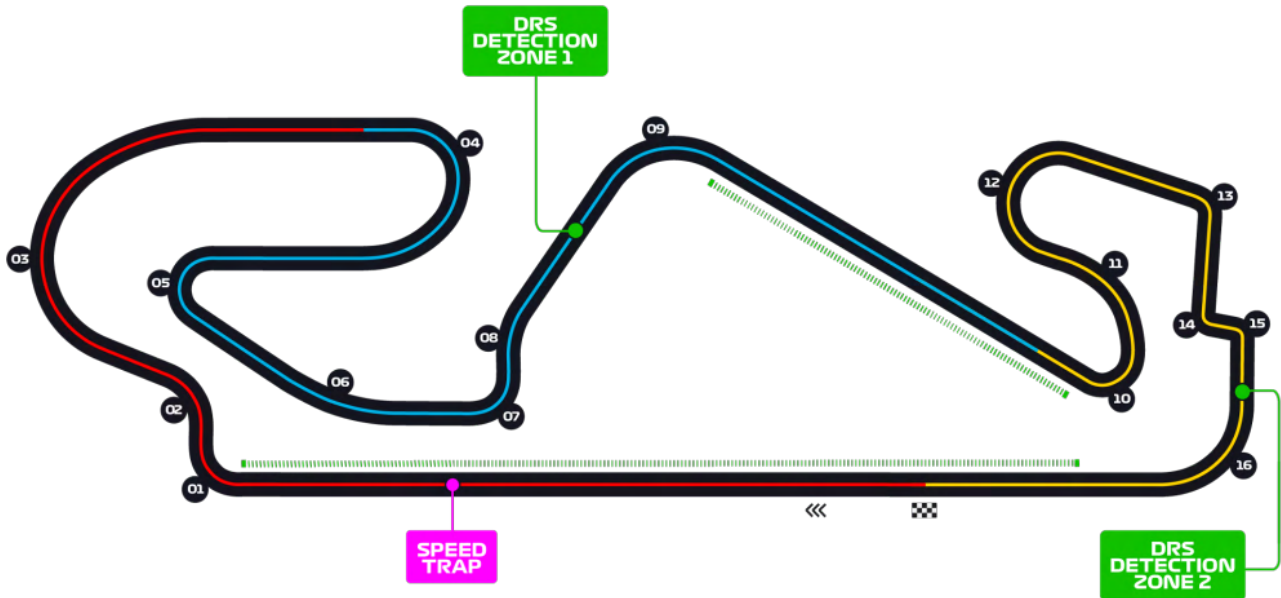

The Circuit de Catalunya was built in 1989 through the efforts of a Consortium composed of the Catalan Government, the Reial Automòbil Club de Catalunya (RACC) and the Montmeló Town Council. In September 1991, the 35th Spanish F1 Grand Prix was held following a seventeen-year of absence in Catalonia. Today, the circuit is a familiar site for teams and drivers as the track is used for extensive offseason testing. The circuit underwent resurfacing and track modifications over last year's winter and is a good mix of high- and low-speed corners, with the challenging Turn 3 right-hander a great chance to evaluate the balance of the car.

The track offers plenty of choice for spectators with almost the whole track overlooked by grandstands or general admission areas. On the outside of Turn 1, Grandstand A will let you see the best overtaking spot on the track, while the general admission area around Turn 3 will provide the awe-inspiring sight of Formula 1 cars being pushed to the limit of their downforce capabilities.

FORMULA 1 PIRELLI GRAND PRIX DU CANADA 2023
CIRCUIT GILLES VILLENEUVE

Date	16 - 18 Jun	Race distance	305.27 km
Circuit length	4.361km	Number of laps	70

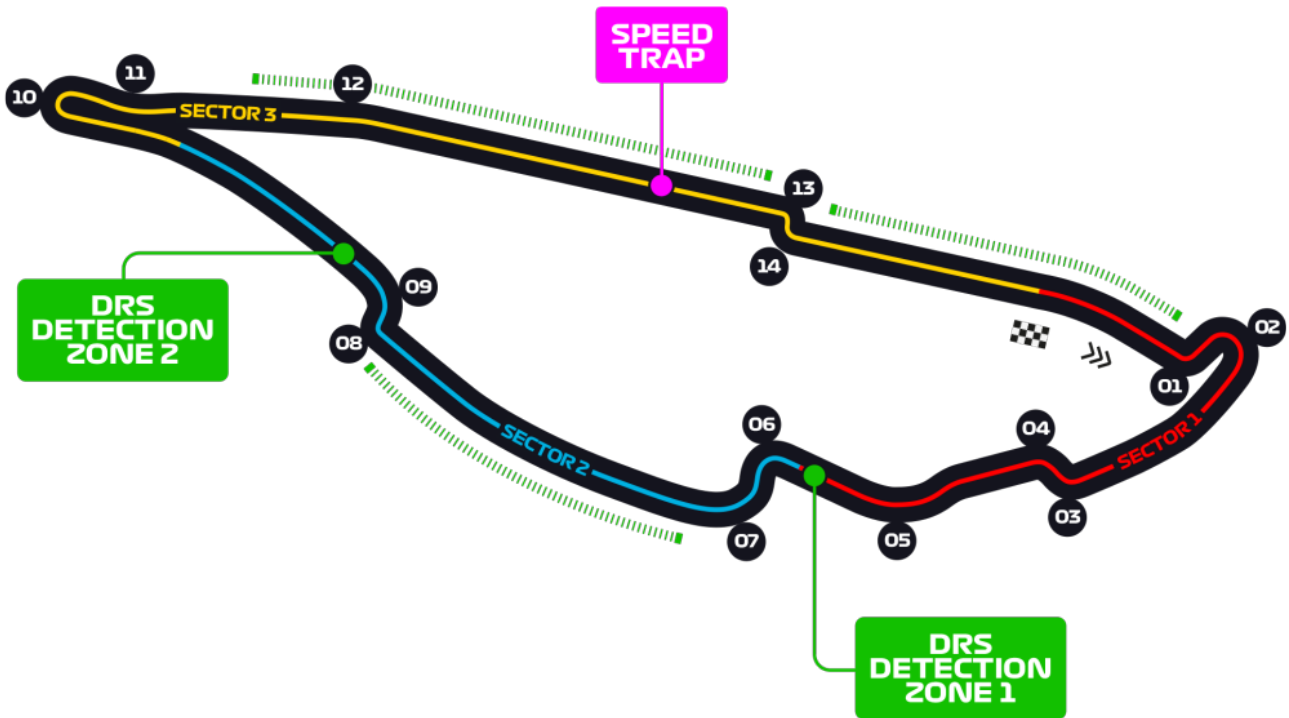

The fast, low-downforce circuit is one of the drivers' favourites. The track is quite stop-start, with lots of heavy-braking chicanes and the famous hairpin to get the anchors working hard. Out of the corners, though, the track is quick and flowing, while the most iconic piece of the circuit comes right at the end of the lap: the Wall of Champions, so-called after excursions into it from Damon Hill, Jacques Villeneuve and Michael Schumacher during the 1999 Canadian Grand Prix weekend.

**FORMULA 1 GROSSER PREIS VON OSTERREICH 2023
SPIELBERG**

Date	03 Jun - 02 Jul	Race distance	306.452 km
Circuit length	4.318km	Number of laps	71

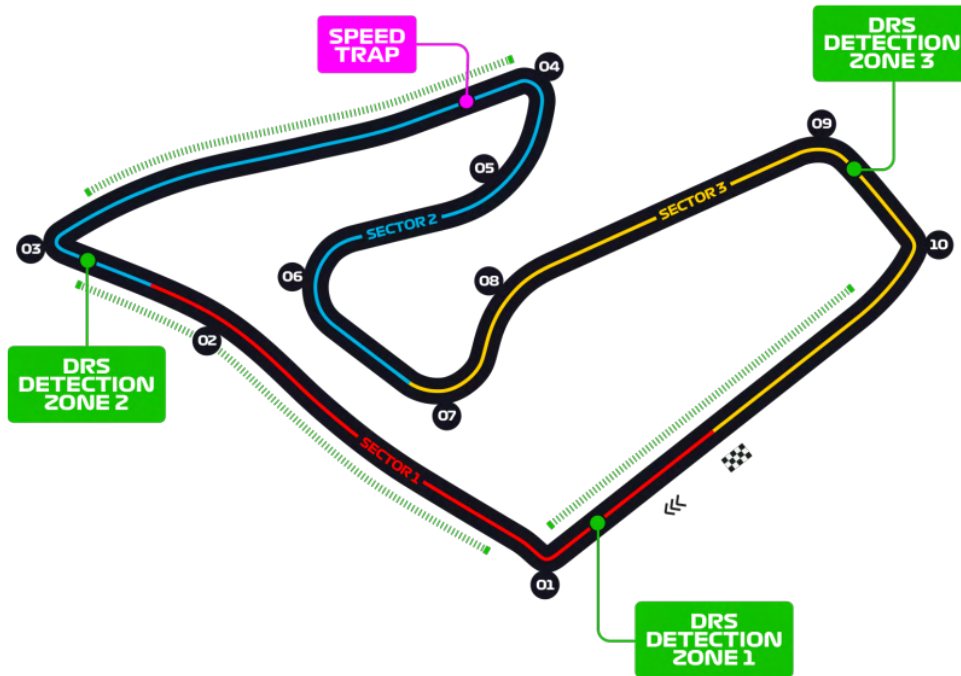

Previously known as the A1-Ring Formula 1 arrived there in 1997, one year after the track was opened.

The Red Bull Ring packs a lot into a short lap. The first half rewards power, as the cars blast along three straights separated by a pair of uphill right-handers. But then as the drivers work their way downhill, the circuit becomes a regular toboggan ride, as the cars canyon through a series of quick corners, including the exhilarating Rindt right-hander, named for Austria's first F1 champion.

**FORMULA 1 ARAMCO BRITISH GRAND PRIX 2023
SILVERSTONE**

Date	07 - 09 Jul	Race distance	306.198 km
Circuit length	5.891 km	Number of laps	52

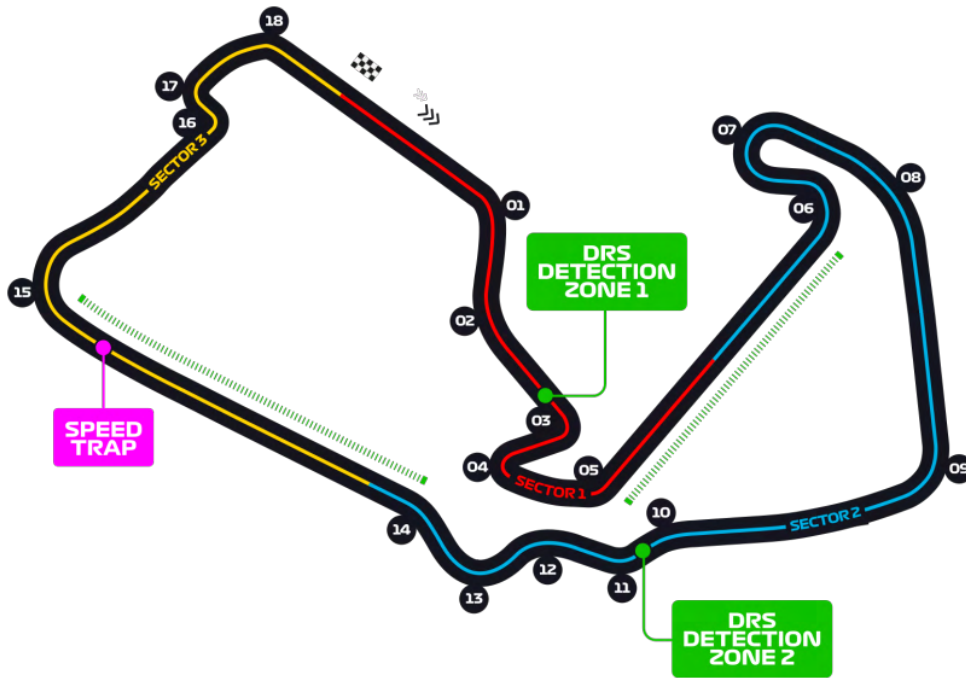

The inaugural of the first Formula 1 World Championship round on May 13th, 1950 was hosted at Silverstone. Since it continues to be a top draw for fans of Formula 1, offering a rich tradition of racing, a fast and challenging track, as well as the constant prospect of weather playing a critical role in race day strategy. It's hard to stop the goose bumps from prickling as you walk around one of the great cathedrals of motorsport, while in terms of atmosphere, the British fans are always reliably raucous.

At the 2018 British Grand Prix, Lewis Hamilton compared a flat-out lap around Silverstone to flying a fighter jet, which should tell you all you need to know about the Northamptonshire circuit. Despite numerous layout changes over the years, Silverstone has always maintained its essential character as one of the fastest tracks on the F1 calendar, while historic corners like Maggotts, Becketts and Abbey provide some of the biggest challenges for racing drivers anywhere in the world.

**FORMULA 1 QATAR AIRWAYS HUNGARIAN GRAND PRIX 2023
BUDAPEST**

Date	21 - 23 Jul	Race distance	306.630 km
Circuit length	4.381 km	Number of laps	70

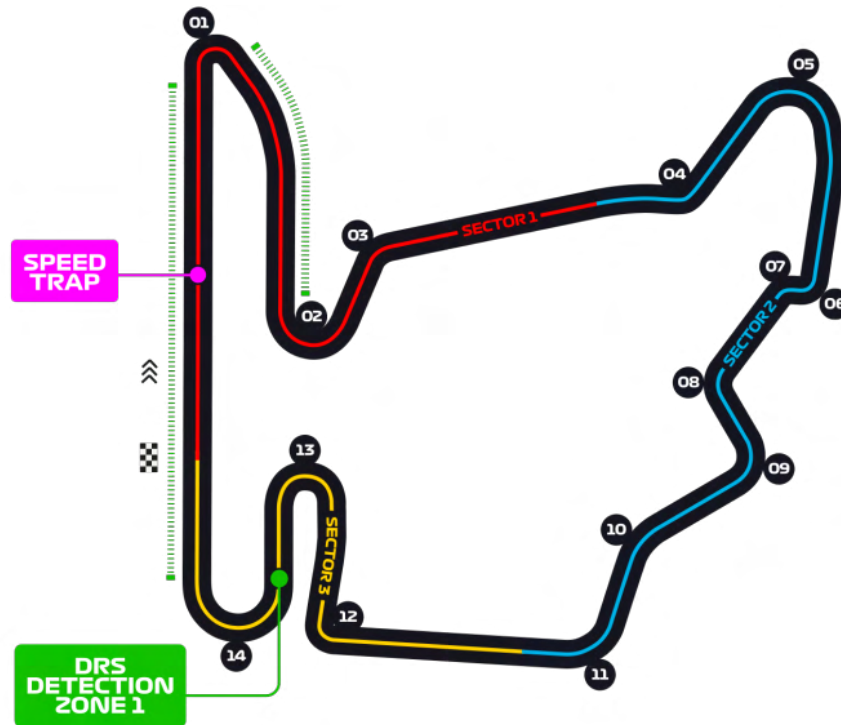

Home of the first Grand Prix to have been held behind the “Iron Curtain” in 1986. The Hungaroring was built in record time and remains today a major attraction in Hungary.

Held in the summer, the circuit is built in a natural bowl allowing excellent vantage points for spectators. That means that any of the grandstands located on or around the main straight should provide a view of other parts of the track too.

The lack of straights at the Hungaroring often sees it compared to a karting circuit - and it’s true, the resemblance is uncanny. With several series of corners to string together, teams opt for Monaco levels of downforce, with a well-sorted chassis tending to be rewarded over horsepower given the short straights on offer. It’s a challenge many of the drivers relish, however, with finding a good rhythm key to setting fast lap times.

**FORMULA 1 MSC CRUISES BELGIAN GRAND PRIX 2023
SPA - FRANCHORCHAMPS**

Date	28 - 30 Jul	Race distance	308.052 km
Circuit length	7.004 km	Number of laps	44

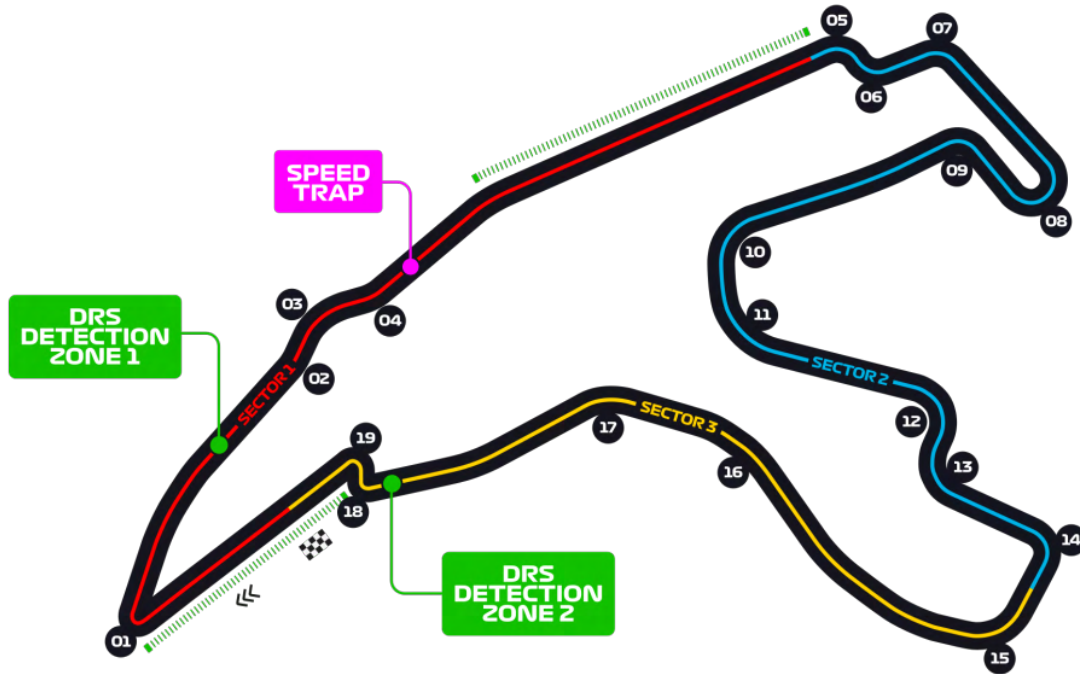

The Circuit de Spa-Francorchamps is legendary among race enthusiasts for its long-standing history and unique setting. It is considered one of the most challenging tracks in the world, mainly due to its fast, hilly, and twisty layout within the Ardennes Forest. The size of the track and the nature of Belgian weather means it can sometimes be raining on one part of the track and dry on another, meaning grip can vary from one corner to the next.

Spa is among Formula 1 drivers' most loved tracks, with its mix of long straights and challenging fast corners allowing them to push their cars to the edge of their capabilities - if it's dry, that is. The size of the track and the nature of Belgian weather means it can sometimes be raining on one part of the track and dry on another, meaning grip can vary from one corner to the next. Keep an eye on the thrilling Eau Rouge, arguably the most famous sequence of corners in the world, as the drivers flick left, right, and then up the hill through Raidillon.

FORMULA 1 HEINEKEN DUTCH GRAND PRIX 2023 ZANDVOORT

Date	25 - 27 Aug	Race distance	306.587 km
Circuit length	4.259 km	Number of laps	72

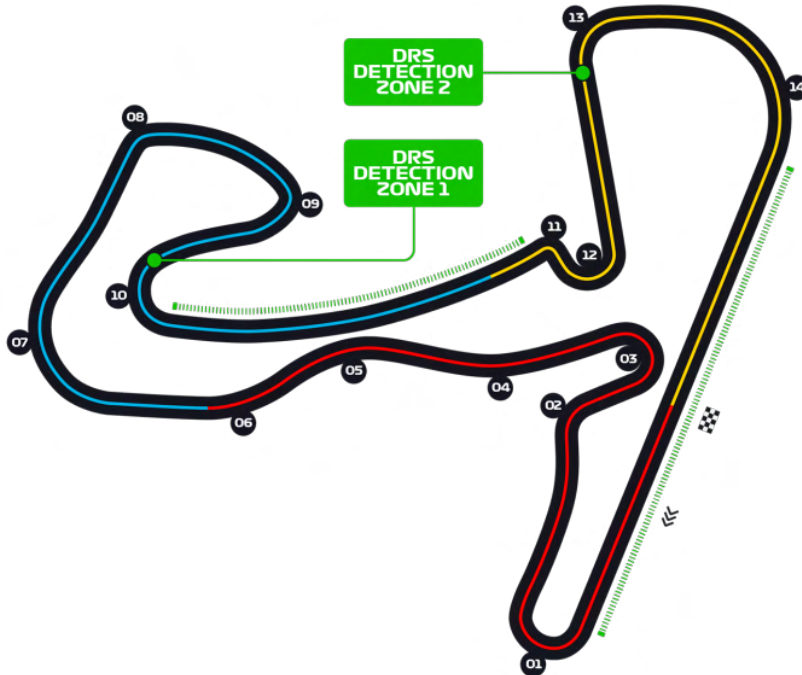

Zandvoort was first opened in 1948, part of the wave of post-war motorsport enthusiasm that swept across Europe. Originally made up of a mixture of permanent track and public roads that snaked through the sand dunes of the Zandvoort resort town, the Dutch Automobile Racing Club - who initiated the plans for the circuit - brought in 1927 Le Mans winner Sammy Davis to consult on the layout for the original 4.2km track. After a break since 1985, Formula 1 returned to Zandvoort in 2021.

The current F1 drivers describe the track 'really quick', 'pretty insane', 'crazy' and 'old-school' that many of them tackled in their junior category days. We'd also add 'undulating' to that list. The Zandvoort track swoops and flows through the sand dunes, creating a rollercoaster-like feel to the lap.

FORMULA 1 PIRELLI GRAN PREMIO D'ITALIA 2023 MONZA

Date	01 - 03 Sep	Race distance	306.72 km
Circuit length	5.793 km	Number of laps	53

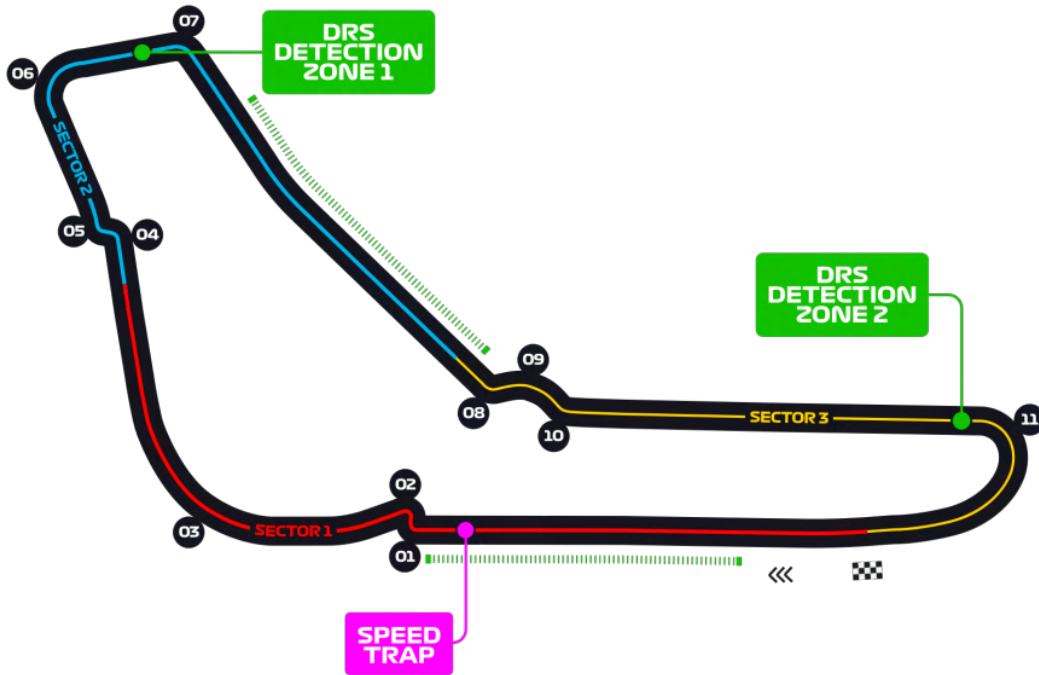

The Autodromo Nazionale Monza was built in just 110 days and is the world's third purpose-built racetrack, coming after Brooklands in the UK and Indianapolis in the US. Monza opened its doors on September 3, 1922, just a week before it hosted that year's Italian Grand Prix. It was then part of the original Formula 1 calendar in 1950 and has held the Italian Grand Prix every year bar one since.

Formula 1's fastest ever lap was set at Monza - Williams driver Juan Pablo Montoya's 260.6km/h effort during practice for the 2004 Grand Prix - which should give you some idea of the nature of the track the locals call 'La Pista Magica'. Cars are on full throttle for 80% of the lap and hit their Vmax on the circuit's 1.1km start/finish straight. From there, they roar off into the historic park section, where a series of big stops into tight chicanes give the brakes a good workout.

**FORMULA 1 SINGAPORE AIRLINES SINGAPORE GRAND PRIX 2023
MARINA BAY STREET CIRCUIT**

Date	15 - 17 Sep	Race distance	308.706 km
Circuit length	5.063 km	Number of laps	61

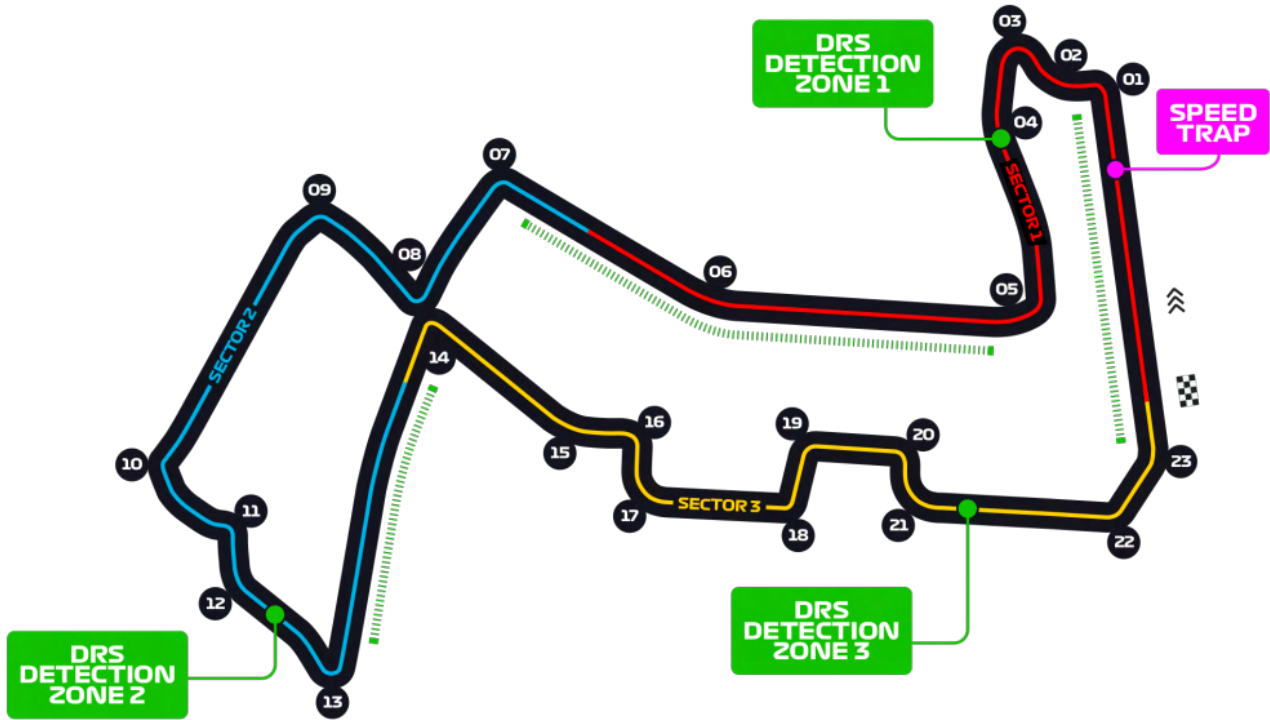

In 2008, Singapore had the honour of hosting the first night-time race in F1 history. The Grand Prix - the 15th round of that season - proved a huge hit with the teams and drivers, while Renault's Fernando Alonso claimed a controversial victory.

The 5.063km Marina Bay Circuit is one of the most physically demanding on the calendar, its bumpy street surface coupled with humid conditions giving the drivers plenty to think about. With 23 corners, they are working the wheel a lot, too, around the high-speed lap - the physical stress causing them to lose as much as 3kg over the course of a race. The circuit also boasts some of the most unique features of any track on the F1 calendar, including Turn 18, which actually sees the drivers pass underneath a grandstand.

**FORMULA 1 LENOVO JAPANESE GRAND PRIX 2023
SUZUKA INTERNATIONAL RACING COURSE**

Date	22 - 24 Sep	Race distance	307.471 km
Circuit length	5.807 km	Number of laps	53

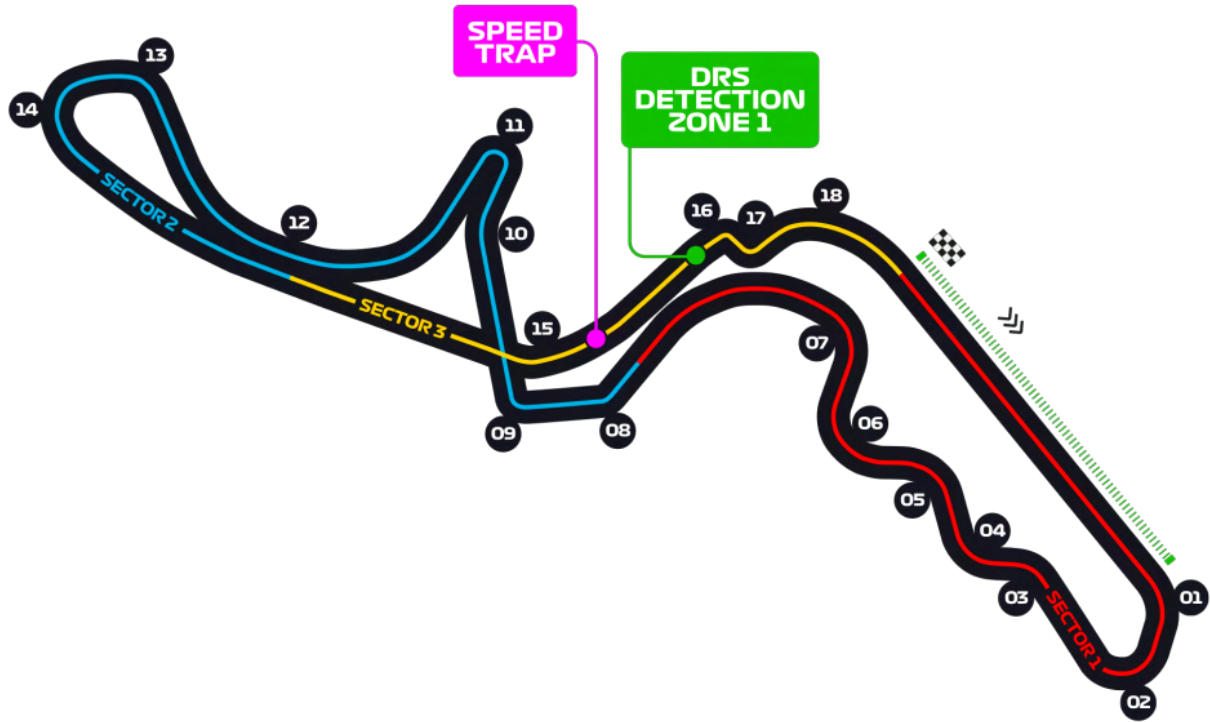

Designed as a Honda test track in 1962, the circuit is another of the racer's favourite, featuring some of the most challenging corners. Among the most popular are the high-speed 130R and the famous Spoon Curve. Its "figure-of-eight" layout also makes the track unique in F1 racing, where the back straight passes over the front via an overpass.

**FORMULA 1 QATAR AIRWAYS QATAR GRAND PRIX 2023
LUSAIL INTERNATIONAL CIRCUIT**

Date	06 - 08 Oct	Race distance	306.66 km
Circuit length	5.38 km	Number of laps	57

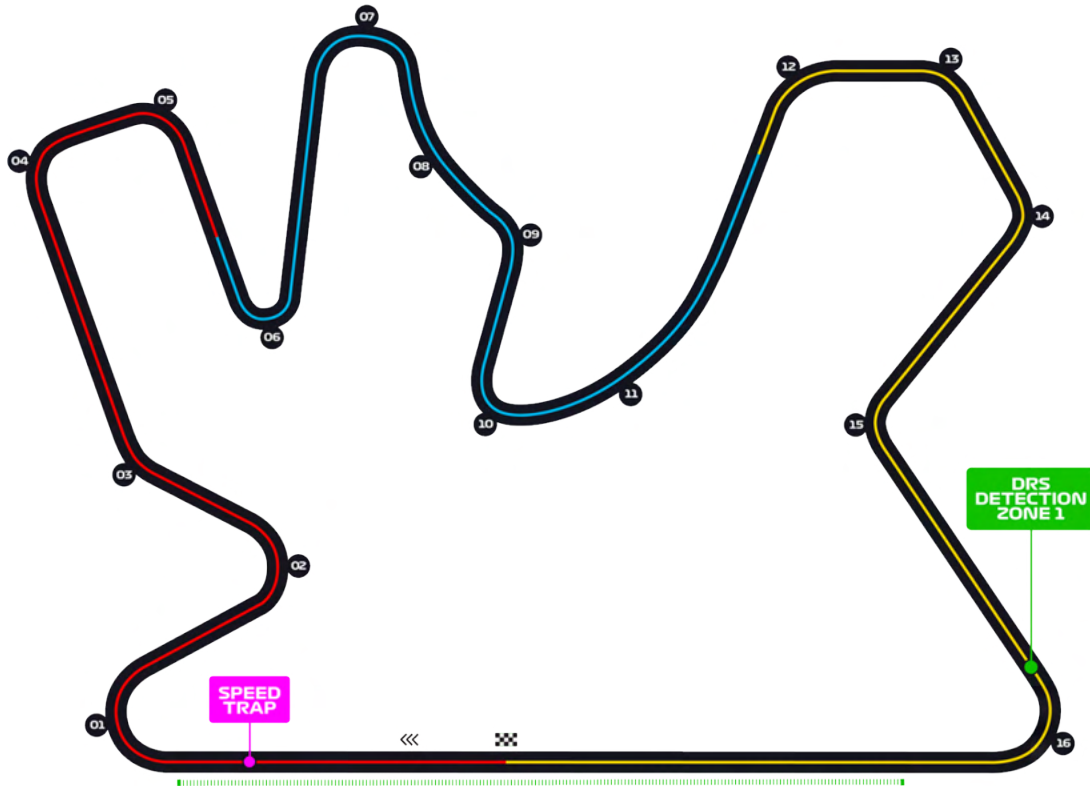

The circuit was built within just over a year in preparation for hosting Qatar's first ever MotoGP event in 2004. In 2021 Qatar hosted Formula 1 for the very first time and signed an additional 10-year deal to host the sport from 2023.

The track is fast and flowing where medium- and high-speed corners predominate. Over one kilometre of the track's total length is made up of the main straight, which provides plenty of overtaking opportunities into Turn 1.

FORMULA 1 LENOVO UNITED STATES GRAND PRIX 2023
CIRCUIT OF THE AMERICAS

Date	20 - 22 Oct	Race distance	308.405 km
Circuit length	5.513 km	Number of laps	56

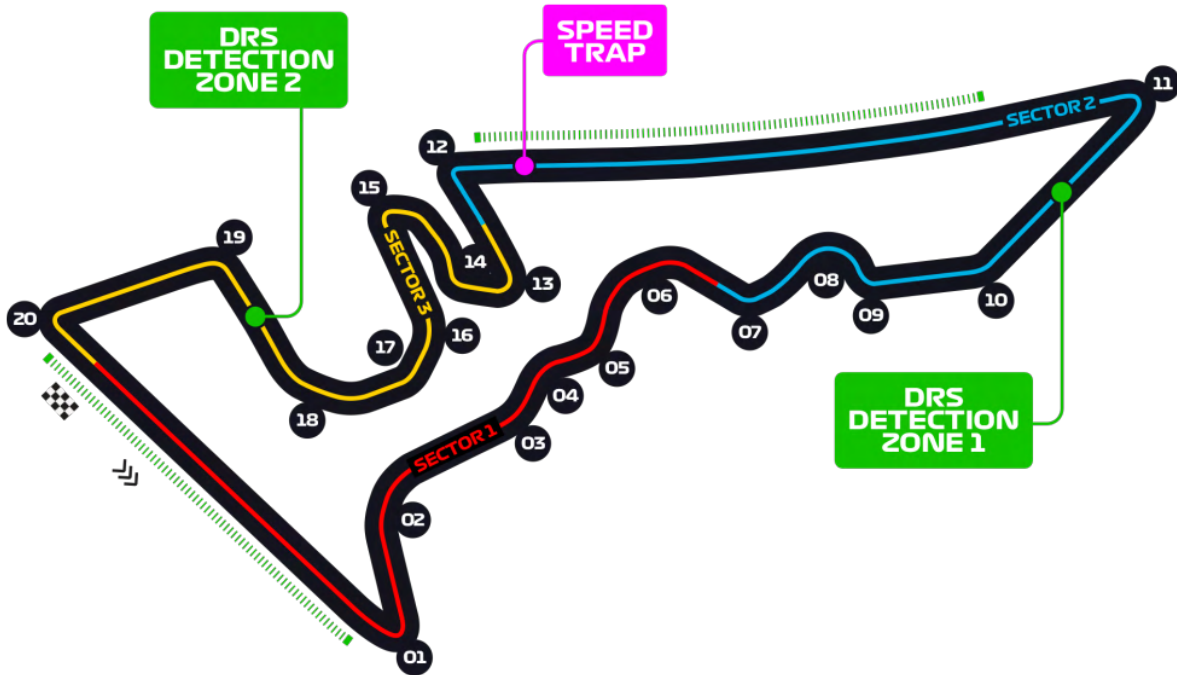

The Circuit of The Americas, designed by Hermann Tilke in collaboration with American architectural firm HKS, endured something of a nervy start, with construction suffering several setbacks. It was well worth the wait, though, when 1978 F1 champion Mario Andretti opened the track on October 21 2012.

If the corners at COTA seem familiar, they should be. Turns 3 through 6 look not dissimilar to Silverstone's high-speed run through Maggotts/Becketts or the S Curves at Suzuka, while Turns 12 through 15 mimic Hockenheim's stadium section. Meanwhile, the uphill run into wide, wide Turn 1 - hey, everything's bigger in Texas, right? - has provided some fine overtaking action in the track's short life.

FORMULA 1 GRAN PREMIO DE LA CIUDAD DE MÉXICO 2023 MÉXICO CITY

Date	27 - 29 Oct	Race distance	305.354km
Circuit length	4.304 km	Number of laps	71

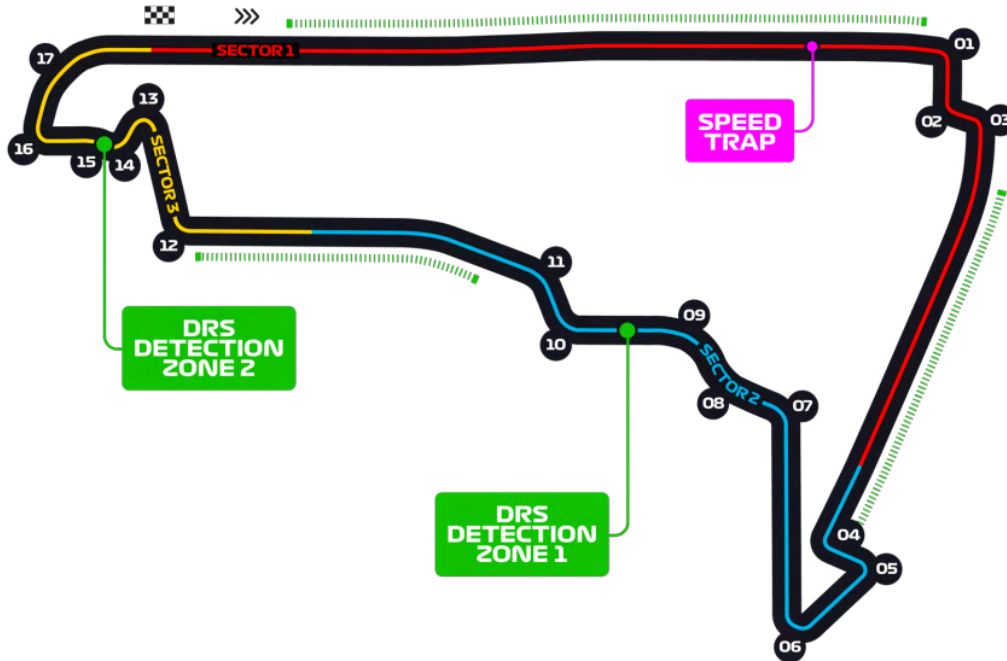

In 1959, the father of Mexico's most famous racing brothers, Ricardo and Pedro Rodriguez, was an advisor to Mexican President Adolfo Lopez Mateo, and had a word in his boss's ear about building a racing circuit in Mexico City's Magdalena Mixiuhca sports park using the existing internal roads. El Presidente liked the idea, and work on the track was completed in under a year.

The racetrack is located over 2,200m above sea level, which makes it the highest altitude venue on the F1 calendar. The thin air at this altitude presents a unique challenge for cars and drivers.

To put it in perspective, Brazil's Interlagos, the second-highest race location, is at around 800m above sea level.

FORMULA 1 ROLEX GRANDE PRÊMIO DE SÃO PAULO 2023 AUTÓDROMO JOSÉ CARLOS PACE

Date	03 - 05 Nov	Race distance	305.879 km
Circuit length	4.309 km	Number of laps	71

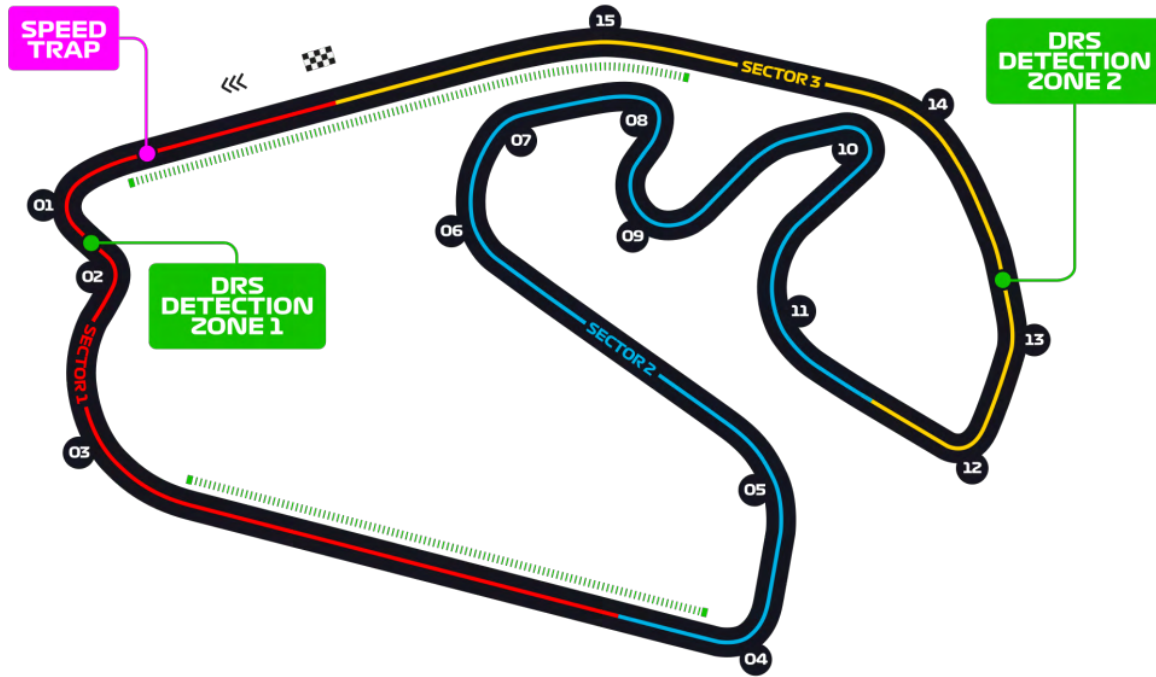

Building work began on what ended up being called the Autodromo Jose Carlos Pace - but what is more commonly referred to as Interlagos - all the way back in 1938. The track designers took their inspiration from three main circuits: Brooklands in the UK, Roosevelt Raceway in the USA and Montlhery in France.

Buoyed by the success of Brazil's Emerson Fittipaldi, Formula 1 first jetted into Interlagos for a world championship race in 1973. Fans were treated to a home win in the first three Brazilian Grands Prix, with Fittipaldi victorious in 1973 and 1974, while Carlos Pace won in 1975.

**FORMULA 1 HEINEKEN SILVER LAS VEGAS GRAND PRIX 2023
LAS VEGAS**

Date	16 - 18 Nov	Race distance	305.88 km
Circuit length	6.12 km	Number of laps	50

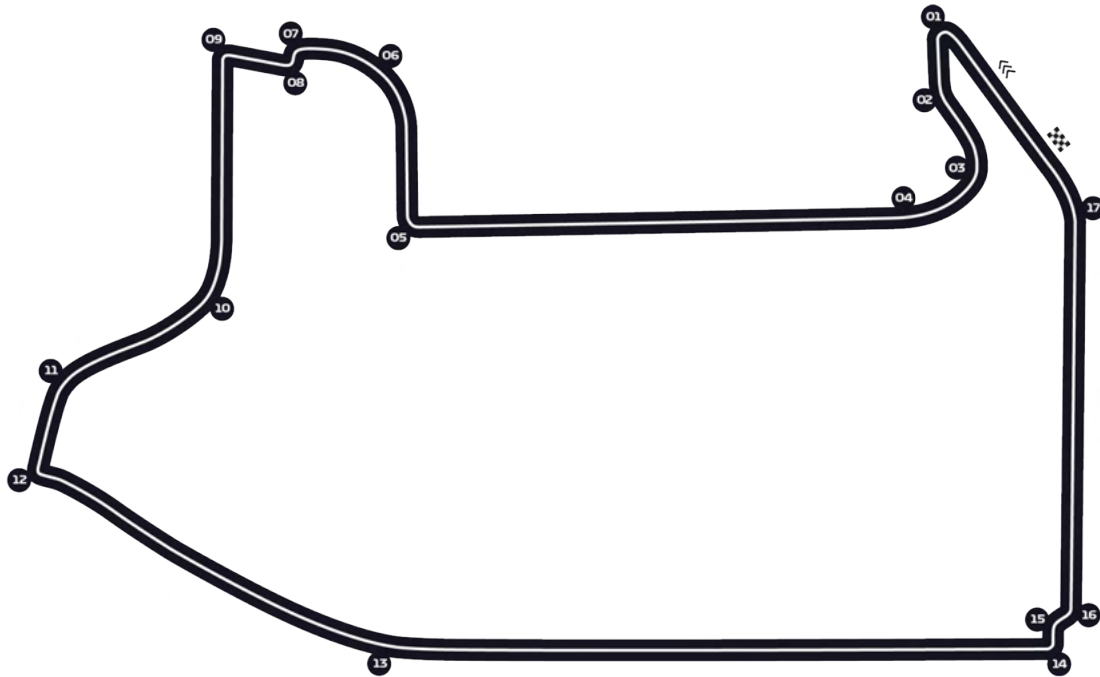

Las Vegas hosted two Formula 1 race in 1981 and 1982 on a temporary track next to the Caesars Palace hotel. This years' return to Formula 1 will take place in the heart of downtown Las Vegas - the new 6.12km, 14-turn street circuit winds its way past iconic locations like the aforementioned Caesars Palace, the Bellagio and the Venetian. With average speeds expected to match Monza, otherwise known as F1's "Temple of Speed", there promises to be plenty of action and overtaking.

FORMULA 1 ETIHAD AIRWAYS ABU DHABI GRAND PRIX 2023 YAS MARINA CIRCUIT

Date	24 - 26 Nov	Race distance	306.183 km
Circuit length	5.281 km	Number of laps	58

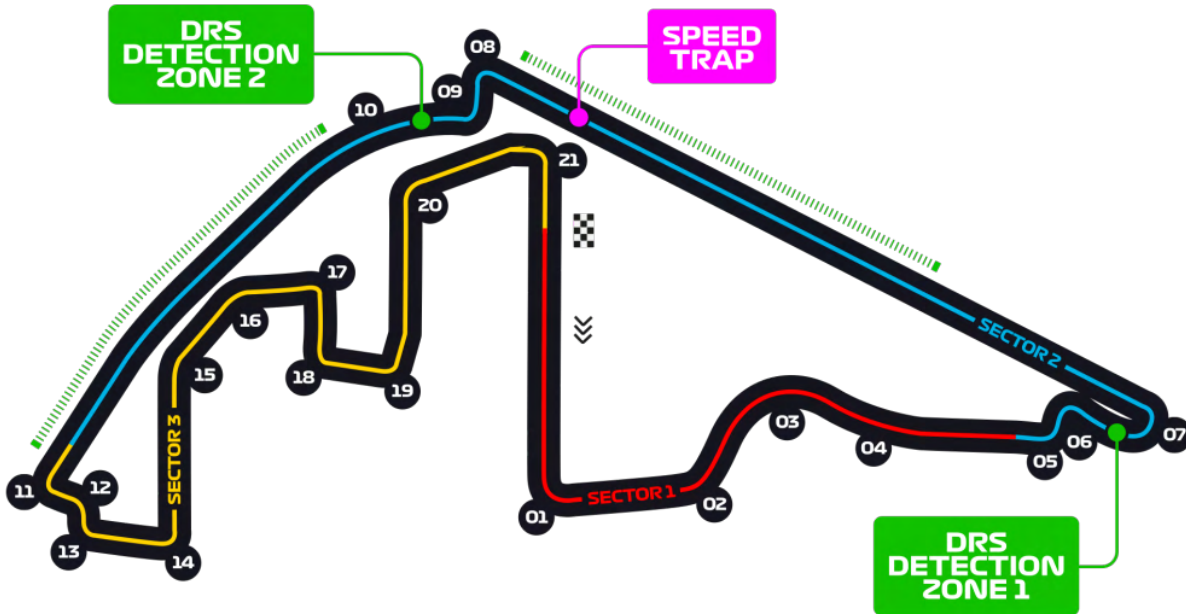

The Hermann Tilke-designed track, inaugurated in 2009 and located on Yas Island is Formula One's first ever day-night race, starting in the afternoon and finishing after sunset. Floodlights are activated from the start of the race to provide a transition into the evening.

The circuit is dominated by its 1.2km straight between Turns 7 and 8 - which, with slow-speed corners marking its beginning and end, makes it a honeypot for overtaking moves. Other highlights include the tricky run through Turns 15 and 16 into 17, which forces the drivers to brake hard with bags of lateral load still on the car.

6. SUPPORT RACE

6.1. PORSCHE DELUXE CARRERA CUP NORTH AMERICA

INTRODUCTION

Porsche Deluxe Carrera Cup North America is the premier one-make race series in the United States and Canada utilizing a combination of the latest Porsche 911 GT3 Cup racecar, type 992, and MICHELIN® Pilot® Sport Cup N3 racing slick to challenge the best road and street race courses on the continent. The third season of the championship is scheduled to host 16-rounds at eight venues. Each 40-minute race counts toward a season-long driver and team championship in each of three classes: Pro, Pro-Am and Am.

As the pinnacle one-make series of the Porsche Motorsport Pyramid North America, the series is a launching point for young drivers looking to move up to open competition. Previous champions Seb Priaulx (2021), Parker Thompson (2022) and two-time runner-up Kay van Berlo have each moved into the IMSA WeatherTech SportsCar Championship with competitive GTD teams in the 2023 season. More on Porsche Deluxe Carrera Cup North America can be found at www.PorscheCarreraCup.us.

WHERE TO WATCH

All rounds of the 2023 Porsche Deluxe Carrera Cup North America will again be found on a wide range of streaming options. IMSA.tv, the NBC Peacock streaming app and PorscheCarreraCup.us will all provide live coverage of each 40-minute race. Once the checkered flag has fallen, all rounds will be archived on the series YouTube channel: Porsche Motorsport North America TV presented by Deluxe (<https://www.youtube.com/c/PorscheMotorsportNorthAmerica>). The experts of IMSARadio will again provide commentary and color for the 16-race championship's race calls.

CALENDAR

<i>Date</i>	<i>Venue</i>
Mar 15 - 16	Sebring International Raceway (IMSA/WEC)
Apr 14 - 16	Long Beach Street Course (IndyCar/IMSA)
May 5 - 7	Miami International Autodrome (Formula 1)
Jun 22 - 25	Watkins Glen International (IMSA)
Jul 27 - 29	Mid-Ohio Sports Car Course (992/991 classes only)
Jul 29 - 31	Road America (NASCAR)
Sep 15 - 17	Indianapolis Motor Speedway (IMSA)
Sep 28 - Oct 1	WeatherTech Raceway Laguna Seca (Rennsport Reunion VII)
Oct 20 - 22	Circuit of the Americas (Formula 1)

CONTACTS

Frank Wiesmann
Porsche Cars North America Manager, Product Communications Office. 770-290-3414 frank.wiesmann@porsche.us

Tom Moore
Motorsports Public Relations
Mobile. 615-509-5000 tom@darkhorseautosport.com



© 2023 Formula One World Championship Limited, a Formula 1 company. The F1 FORMULA 1 logo, F1 logo, FORMULA 1, F1, FIA FORMULA ONE WORLD CHAMPIONSHIP, GRAND PRIX, FORMULA 1 MIAMI GRAND PRIX and related marks are trademarks of Formula One Licensing BV, a Formula 1 company. All rights reserved