



# FEDERATION INTERNATIONALE DE L'AUTOMOBILE

Homologation N°

**KH.005.25**

## FICHE DE PRESENTATION DES CASQUES KARTING (NORME FIA 8878-2024) PRESENTATION FORM FOR KARTING HELMETS (FIA STANDARD 8878-2024)

### 1. GENERALITES / GENERAL

#### 101. CONSTRUCTEUR / MANUFACTURER

##### STILO SRL

- a) Adresse / Address **VIALE MAJNO 45, 20122 MILANO**
- b) Téléphone / Phone **+39 035 690 040**
- c) E-mail / E-mail **INFO@STILO.IT**

#### 102. DATE DE LA FICHE DE PRESENTATION / PRESENTATION FORM DATE

Date / Date **18.02.2025**

#### 103. PHOTO DU CASQUE / PICTURE OF THE HELMET



#### 104. MODELE ET VERSIONS / MODEL AND VERSIONS

##### a) Modèle / Model

##### ST6 CARBON

Nom / Name **ST6 CARBON FN**  
Description / Description **FULL FACE HELMET WITHOUT INTEGRATED PLUG**

A1)



Nom / Name **ST6 CARBON F/GT**  
Description / Description **FULL FACE HELMET WITH INTEGRATED PLUG**

B1)



Nom / Name  
Description / Description

C1)

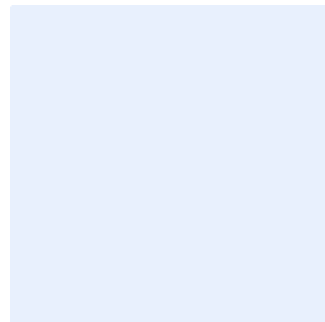

**105. TAILLES DISPONIBLES / SIZES AVAILABLE**

Tailles / Sizes

54, 55, 56, 57, 58, 59, 60, 61, 63, 64

**2. DETAILS DU CASQUE / DETAILS OF THE HELMET**

**201. VUES / VIEWS**

D1) Vue de face / Front view



D2) Vue du Côté Droite / Right Side view



D3) Vue de haut / Top view



**202. MECANISME DE VERROUILLAGE DE LA VISIERE / VISOR LOCKING MECHANISM**

D1) Vue du mécanisme de verrouillage en position de visière fermée  
/ View of the locking mechanism in closed visor position

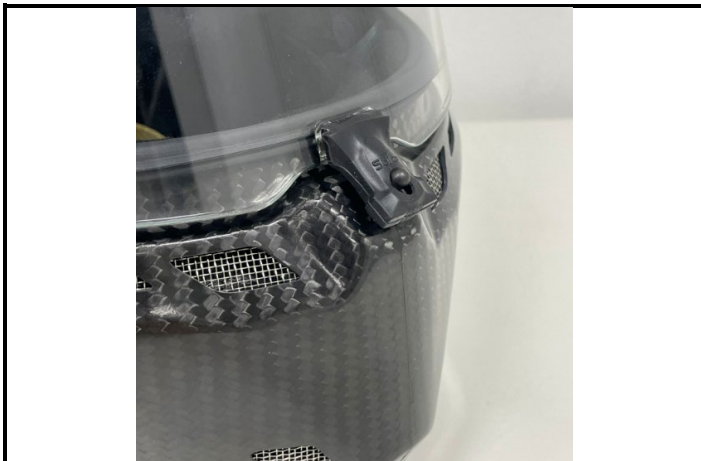

D2) Vue du mécanisme de verrouillage en position de visière ouverte  
/ View of the locking mechanism in open visor position



**203. NOMBRE ET POSITION DES TROUS DE VENTILATION / NUMBER AND POSITION OF VENTILATION HOLES**

	Menton Chin		Top Top
Nombre de trous Number of holes	<b>8 max</b>	Nombre de trous Number of holes	<b>10 max</b>

**3. ACCESSOIRES DISPONIBLES / AVAILABLE ACCESSORIES**

E1) EAR CUPS STILO (WITH OR WITHOUT SPEAKER)



E2) EAR PADS



E3) CLIPS SIDE PORT CONNECTO

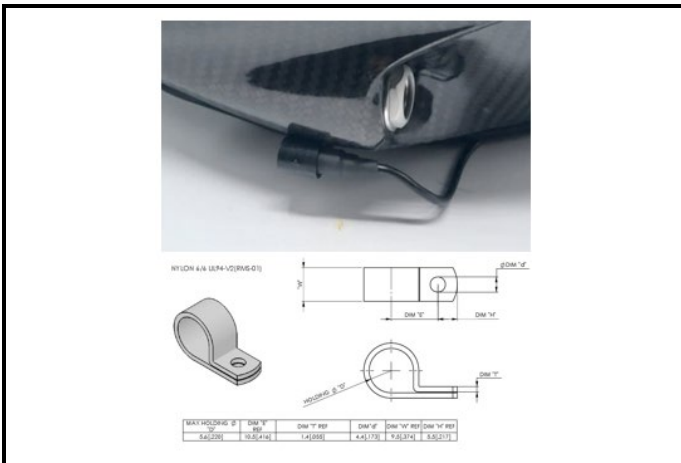

E4) CLIPS SIDE PORT CONNECTO



E5) CHIN DRINK SYSTEM



E6) SIDE PORT DRINK SYSTEM



Marque  
Make **STILO SRL**

Modèle  
Model

**ST6 CARBON**

Homologation N°

**KH.005.25**

E7) INTEGRATED COMM



E8) Chin spoiler short



E9) Chin cover



E10) WL-Key



E11) Chin spoiler std

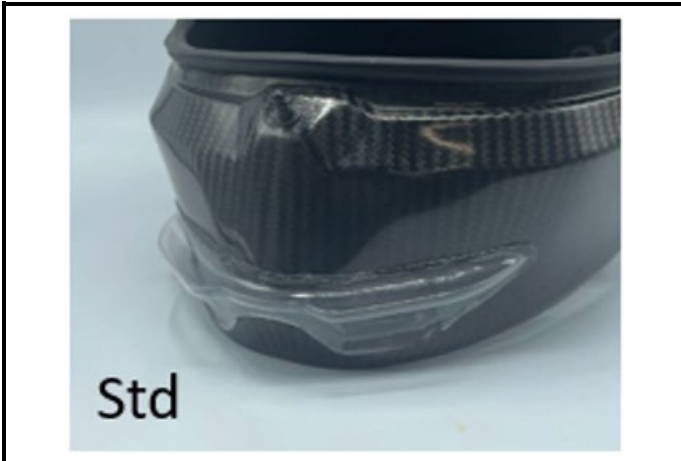

E12) Rear Spoiler V1

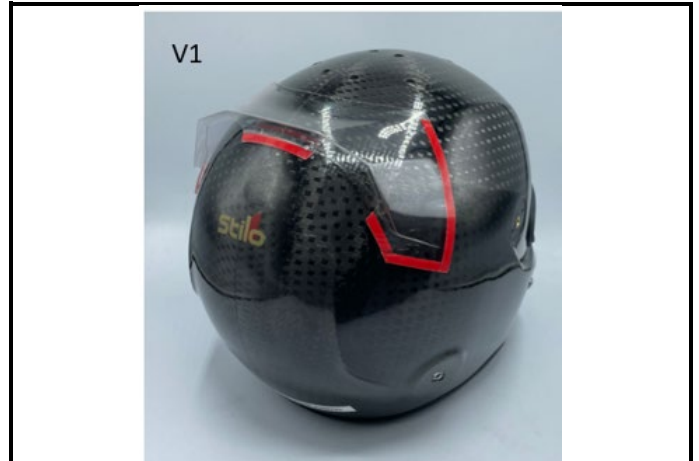

E13) Rear Spoiler V2

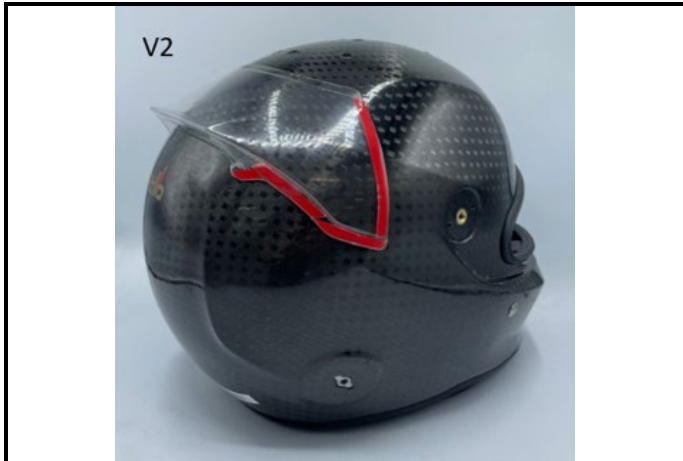

E14) Rear spoiler V3



E15) Rear spoiler V4



E16) Visor trim drag race



E17) Top ventilation air intake



E18) Helmet Camera DE GEN2.5LW



E19) Chin flap



E20) RADIO/INTERCOM CONNECTION KIT



E21) RADIO/INTERCOM CONNECTION KIT



E22)



E23)



E24)



Marque  
Make

**STILO SRL**

Modèle  
Model

**ST6 CARBON**

Homologation N°

**KH.005.25**

**INFORMATIONS COMPLEMENTAIRES / COMPLEMENTARY INFORMATION**

Max 10 top ventilation holes

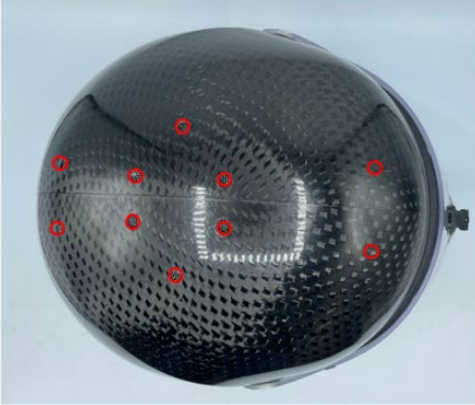

Chin ventilation holes (optional)

