



FEDERATION INTERNATIONALE DE L'AUTOMOBILE

Homologation N°

KC.004.25

FICHE DE PRESENTATION DES CASQUES KARTING (NORME FIA 8878-2024) PRESENTATION FORM FOR KARTING HELMETS (FIA STANDARD 8878-2024)

1. GENERALITES / GENERAL

101. CONSTRUCTEUR / MANUFACTURER

STILO SRL

- a) Adresse / Address **VIALE MAJNO 45, 20122 MILANO**
- b) Téléphone / Phone **+39 035 690 040**
- c) E-mail / E-mail **INFO@STILO.IT**

102. DATE DE LA FICHE DE PRESENTATION / PRESENTATION FORM DATE

Date / Date **18.02.2025**

103. PHOTO DU CASQUE / PICTURE OF THE HELMET



104. MODELE ET VERSIONS / MODEL AND VERSIONS

a) Modèle / Model

ST6 COMPOSITE

Nom / Name **ST6 COMPOSITE FN**
Description / Description **FULL FACE HELMET WITHOUT INTEGRATED PLUG**

A1)



Nom / Name **ST6 COMPOSITE F/GT**
Description / Description **FULL FACE HELMET WITH INTEGRATED PLUG**

B1)



Nom / Name
Description / Description

C1)

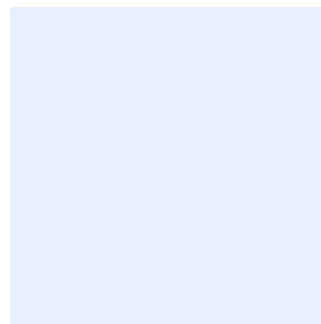

105. TAILLES DISPONIBLES / SIZES AVAILABLE

Tailles / Sizes

54, 55, 56, 57, 58, 59, 60, 61, 63, 64

2. DETAILS DU CASQUE / DETAILS OF THE HELMET

201. VUES / VIEWS

D1) Vue de face / Front view



D2) Vue du Côté Droite / Right Side view



D3) Vue de haut / Top view



202. MECANISME DE VERROUILLAGE DE LA VISIERE / VISOR LOCKING MECHANISM

D1) Vue du mécanisme de verrouillage en position de visière fermée
/ View of the locking mechanism in closed visor position



D2) Vue du mécanisme de verrouillage en position de visière ouverte
/ View of the locking mechanism in open visor position



203. NOMBRE ET POSITION DES TROUS DE VENTILATION / NUMBER AND POSITION OF VENTILATION HOLES

	Menton Chin		Top Top
Nombre de trous Number of holes	8 max	Nombre de trous Number of holes	10 max

3. ACCESSOIRES DISPONIBLES / AVAILABLE ACCESSORIES

E1) EAR CUPS STILO (WITH OR WITHOUT SPEAKER)



E2) EAR PADS



E3) CLIPS SIDE PORT CONNECTO

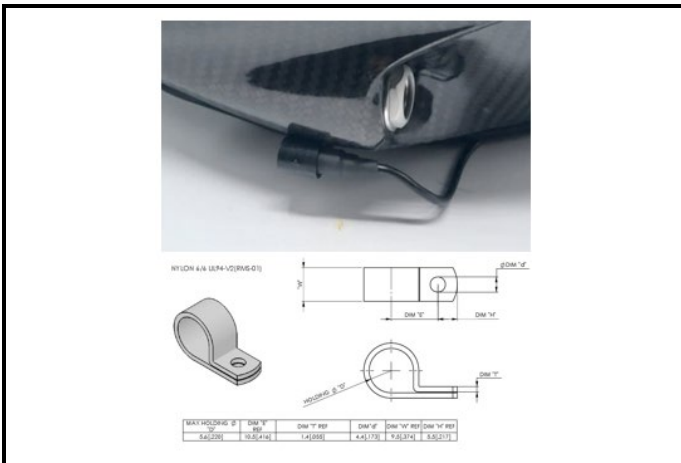

E4) CLIPS SIDE PORT CONNECTO



E5) CHIN DRINK SYSTEM



E6) SIDE PORT DRINK SYSTEM



E7) INTEGRATED COMM



E8) Chin spoiler short



E9) Drag side air



E10) WL-Key



E11) Chin spoiler std

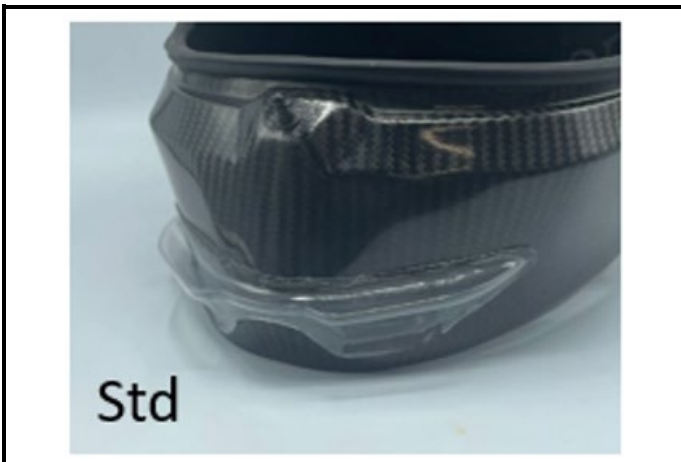

E12) Rear Spoiler V1

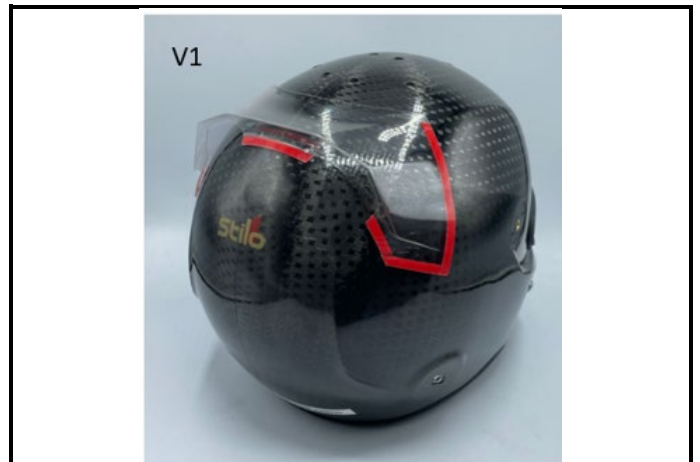

E13) Rear Spoiler V2

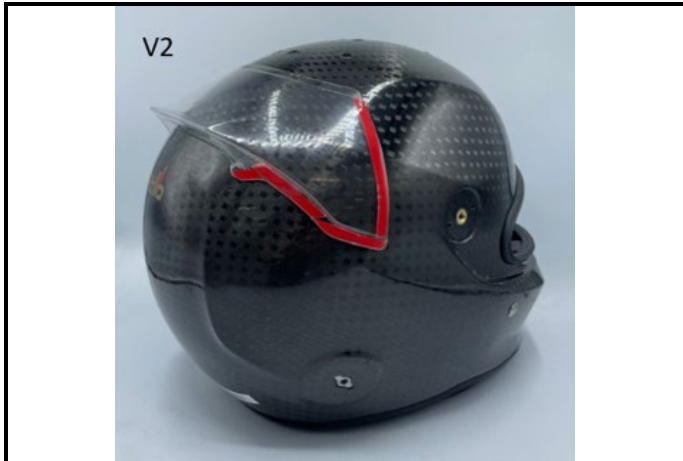

E14) Rear spoiler V3



E15) Rear spoiler V4

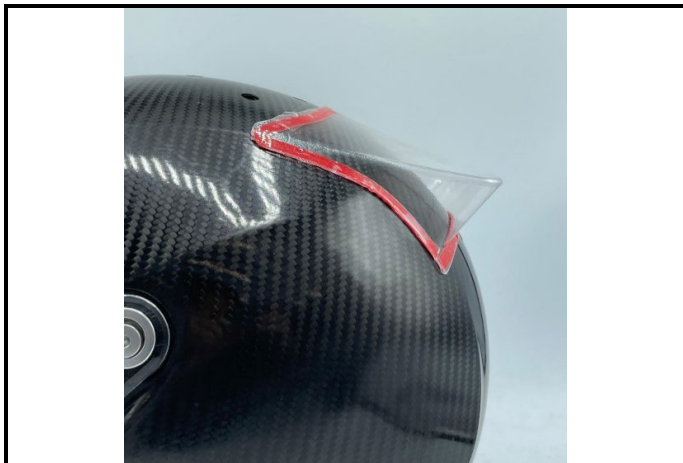

E16) Visor trim drag race

This accessory must always be used with a visor



E17) Top ventilation air intake



E18) Helmet Camera DE GEN2.5LW



E19) Chin flap



E20) RADIO/INTERCOM CONNECTION KIT



E21) RADIO/INTERCOM CONNECTION KIT



E22)



E23)



E24)



INFORMATIONS COMPLEMENTAIRES / COMPLEMENTARY INFORMATION

Max 10 top ventilation holes

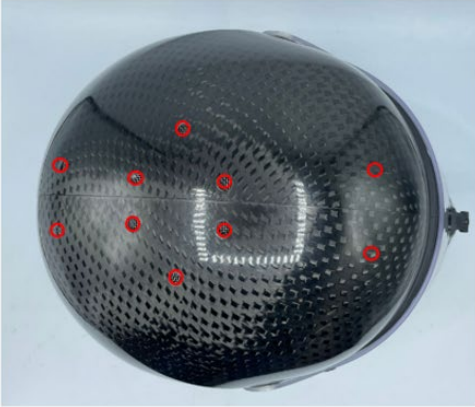

Chin ventilation holes (optional)

