

18" - 20/65-18

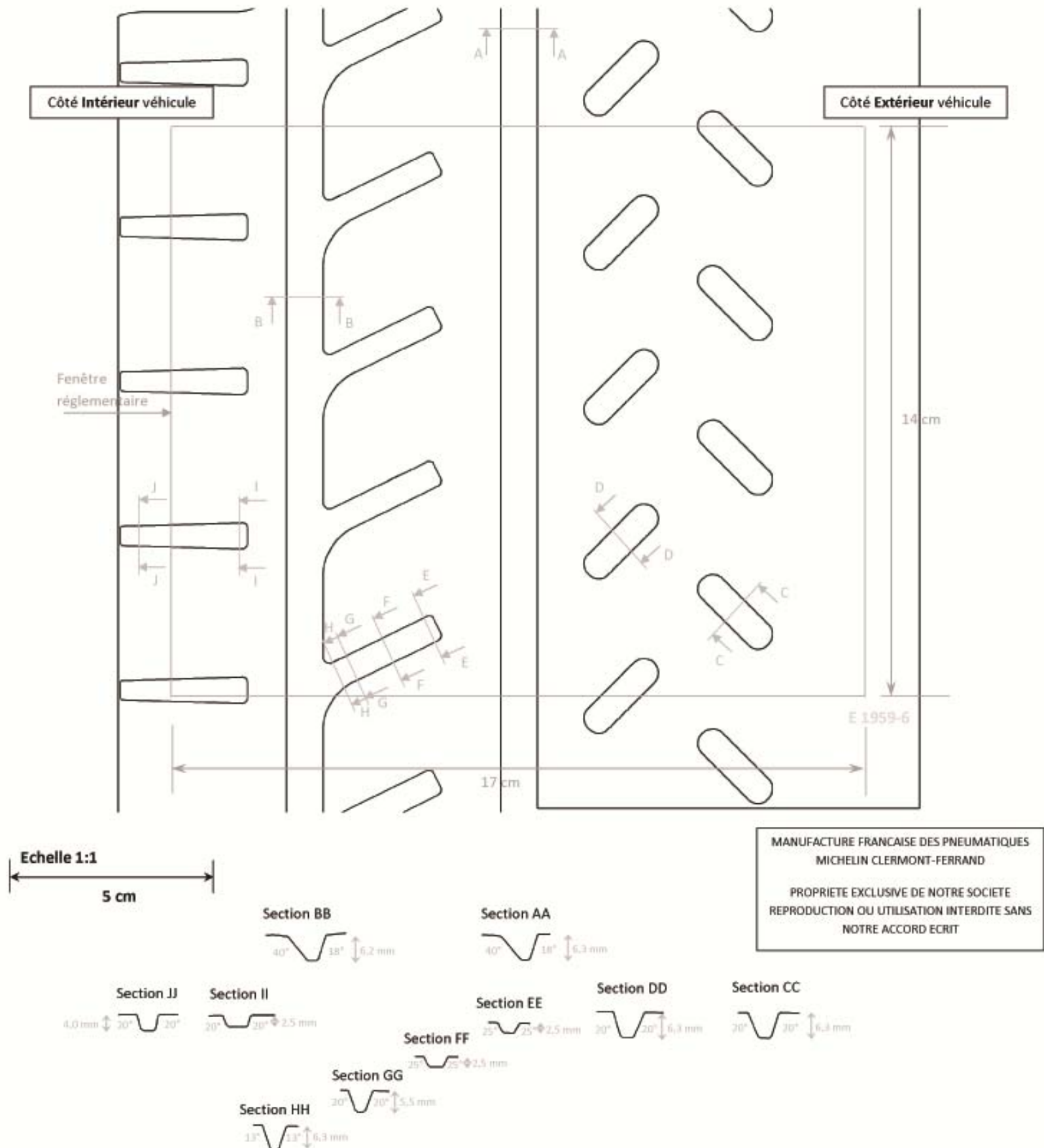

Domaine : Rallye Asphalt
 Dimension : 20 / 65 – 18
 Plan de la sculpture : Pilot Sport R
 Entaillement Surfacing dans fenêtre réglementaire : 21,51 %

Clermont-Ferrand le 05/12/2013



17" - 19/63-17



Domaine : Rallye Asphalte
 Dimension : 19 / 63 – 17
 Plan de la sculpture : **Pilot Sport R**
 Entaillement surfacique sur fenêtre réglementaire : **21,51 %**

Clermont-Ferrand le 05/12/2013

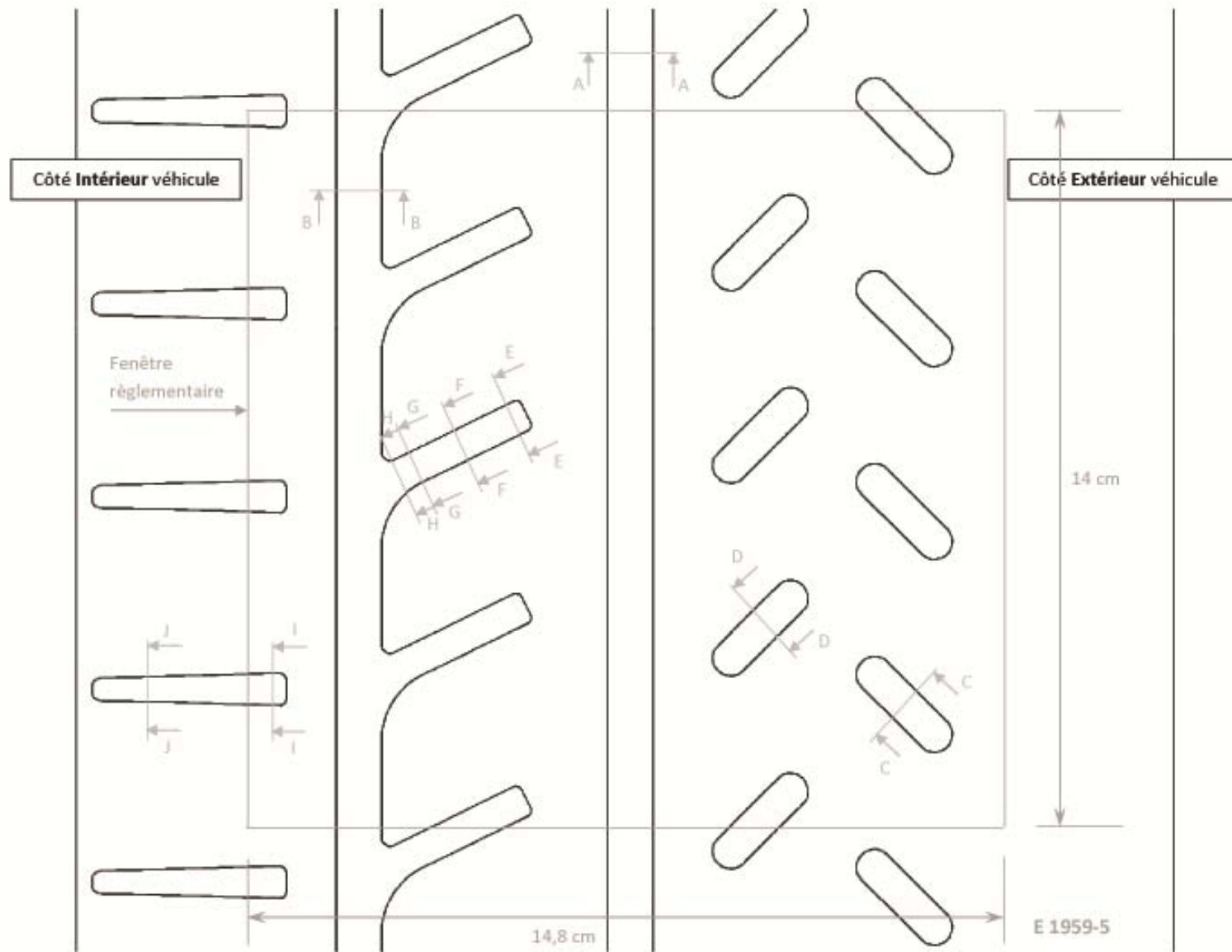

Echelle 1:1
5 cm

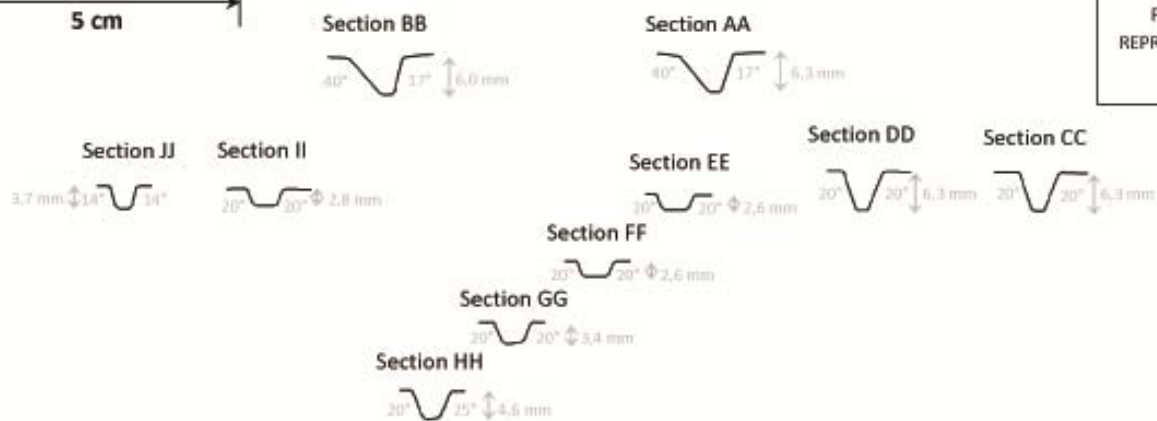

MANUFACTURE FRANCAISE DES PNEUMATIQUES
 MICHELIN CLERMONT-FERRAND
 PROPRIETE EXCLUSIVE DE NOTRE SOCIETE
 REPRODUCTION OU UTILISATION INTERDITE SANS
 NOTRE ACCORD ECRIT

16" – 19/60-16



Domaine : Rallye Asphalt
 Dimension : 19 / 60 – 16
 Plan de la sculpture : **Pilot Sport R**
 Entaillement surfacique sur fenêtre réglementaire : **21,51 %**

Clermont-Ferrand le 05/12/2013

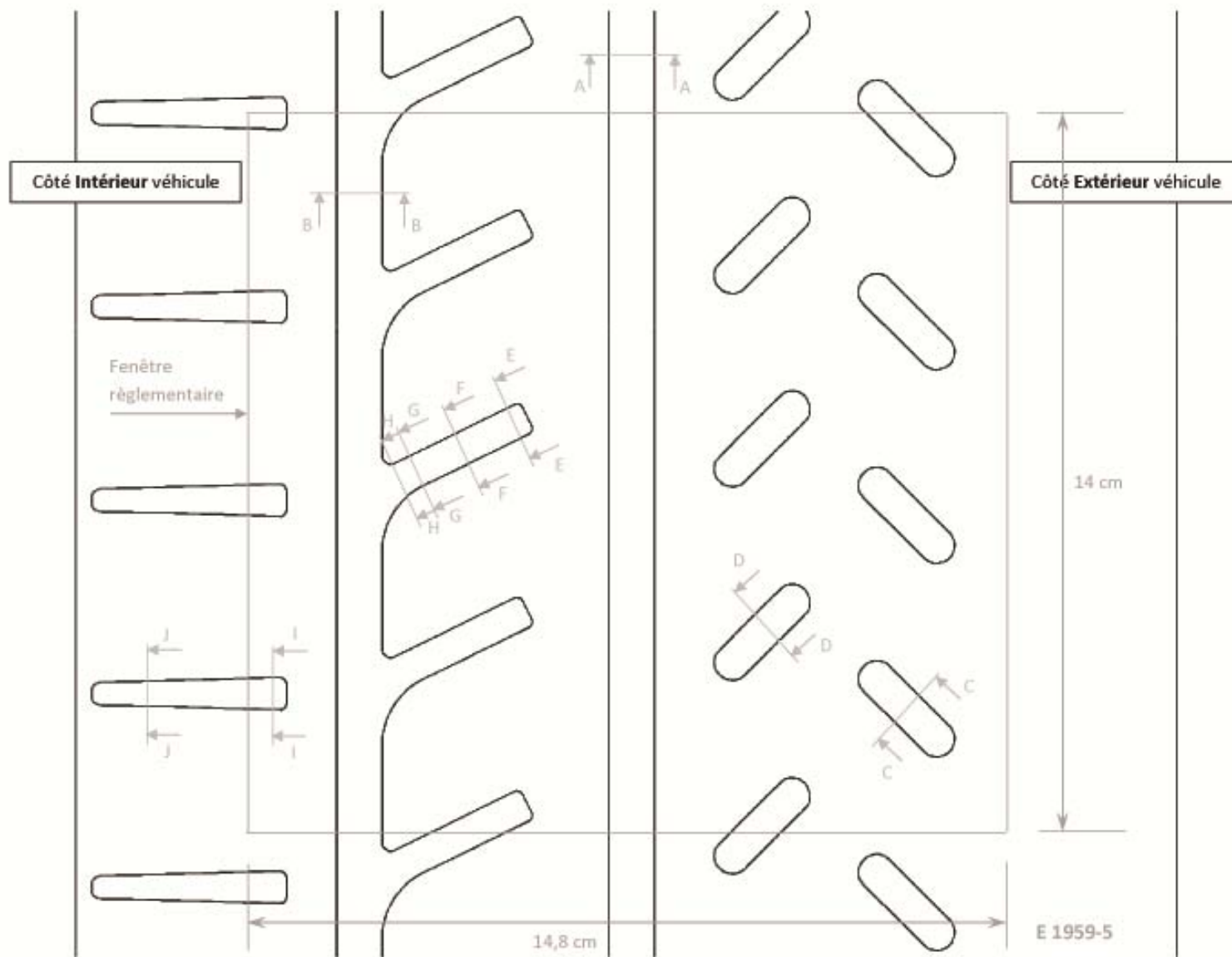

Echelle 1:1
5 cm

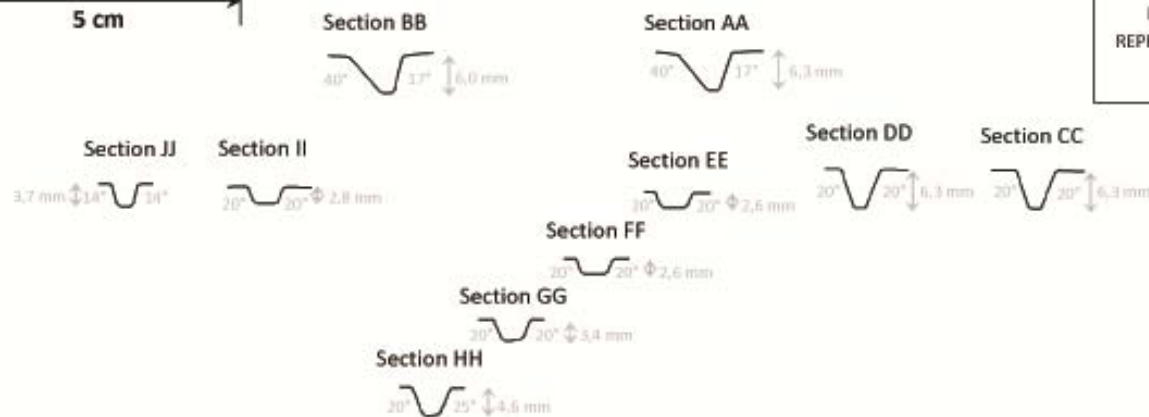

MANUFACTURE FRANCAISE DES PNEUMATIQUES
 MICHELIN CLERMONT-FERRAND
 PROPRIETE EXCLUSIVE DE NOTRE SOCIETE
 REPRODUCTION OU UTILISATION INTERDITE SANS
 NOTRE ACCORD ECRIT

15" – 19/58-15



Domaine : Rallye Asphalte
 Dimension : 19 / 58 – 15
 Plan de la sculpture : **Pilot Sport R**
 Entaillement surfacique sur fenêtre réglementaire : **21,51 %**

Clermont-Ferrand le 05/12/2013

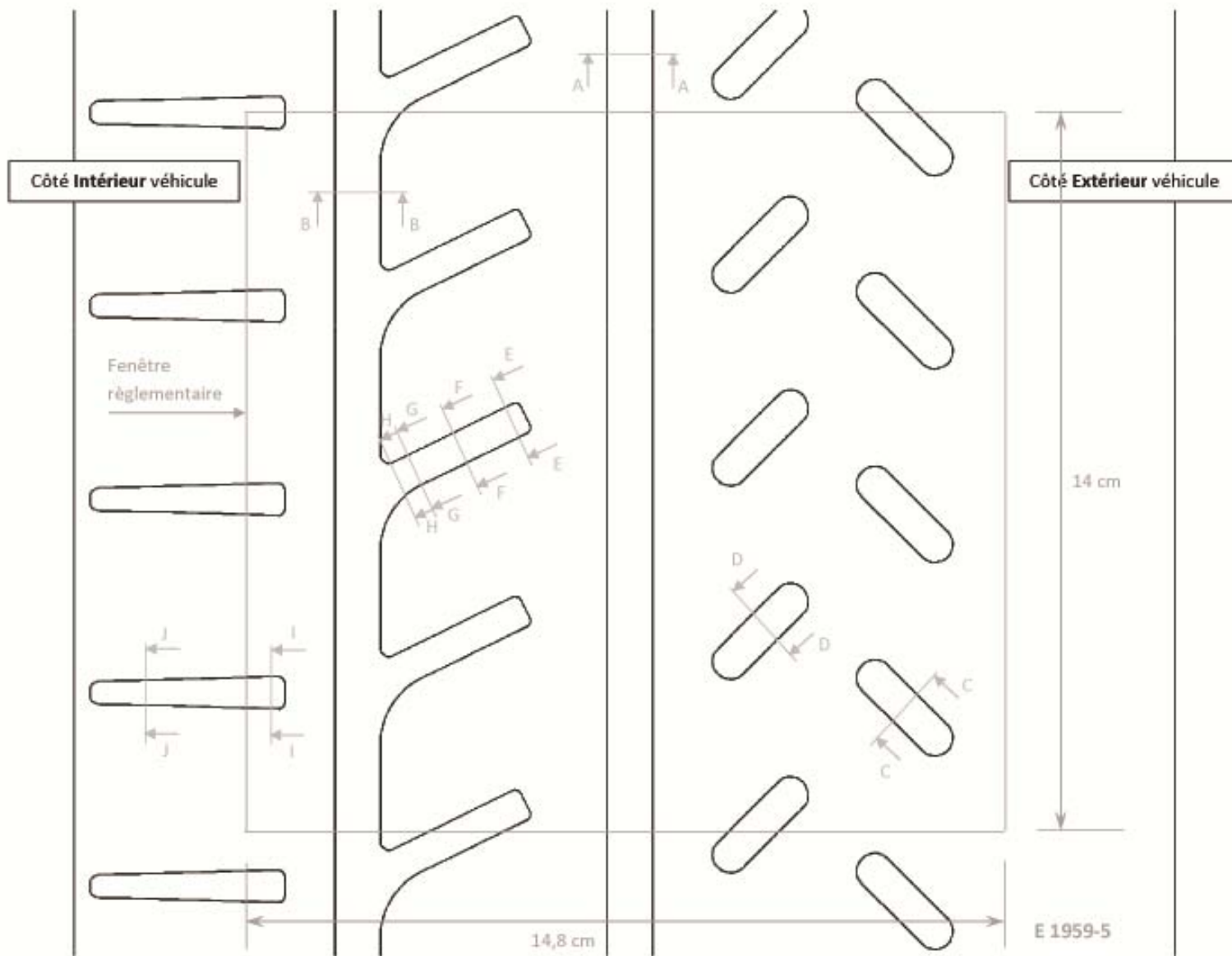

Echelle 1:1
5 cm

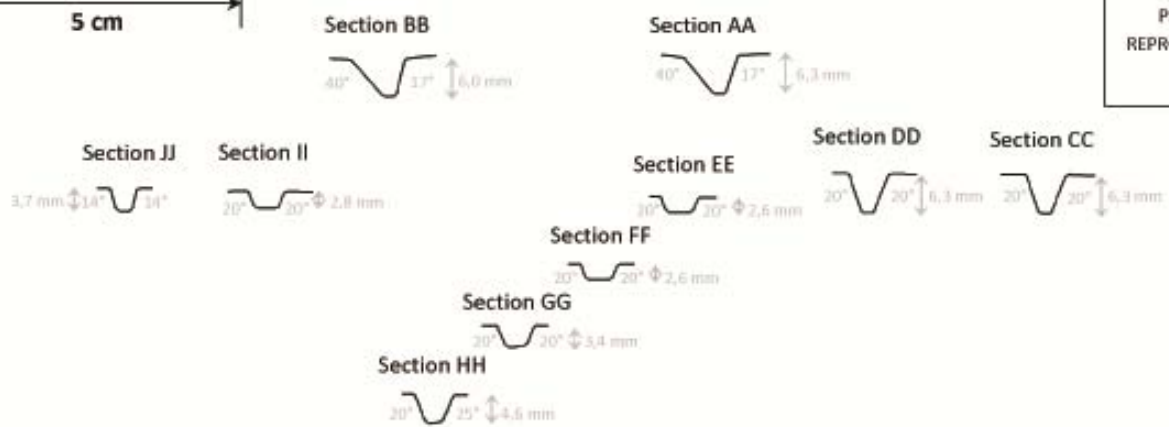

MANUFACTURE FRANCAISE DES PNEUMATIQUES
 MICHELIN CLERMONT-FERRAND
 PROPRIETE EXCLUSIVE DE NOTRE SOCIETE
 REPRODUCTION OU UTILISATION INTERDITE SANS
 NOTRE ACCORD ECRIT

RGT only – 24/65-18



Domaine : Rallye Asphalte
 Dimension : 24 / 65 - 18
 Entaillement surfacique sur une fenêtre de 190 mm de large : 32,8 %

Clermont-Ferrand le 18/12/2013

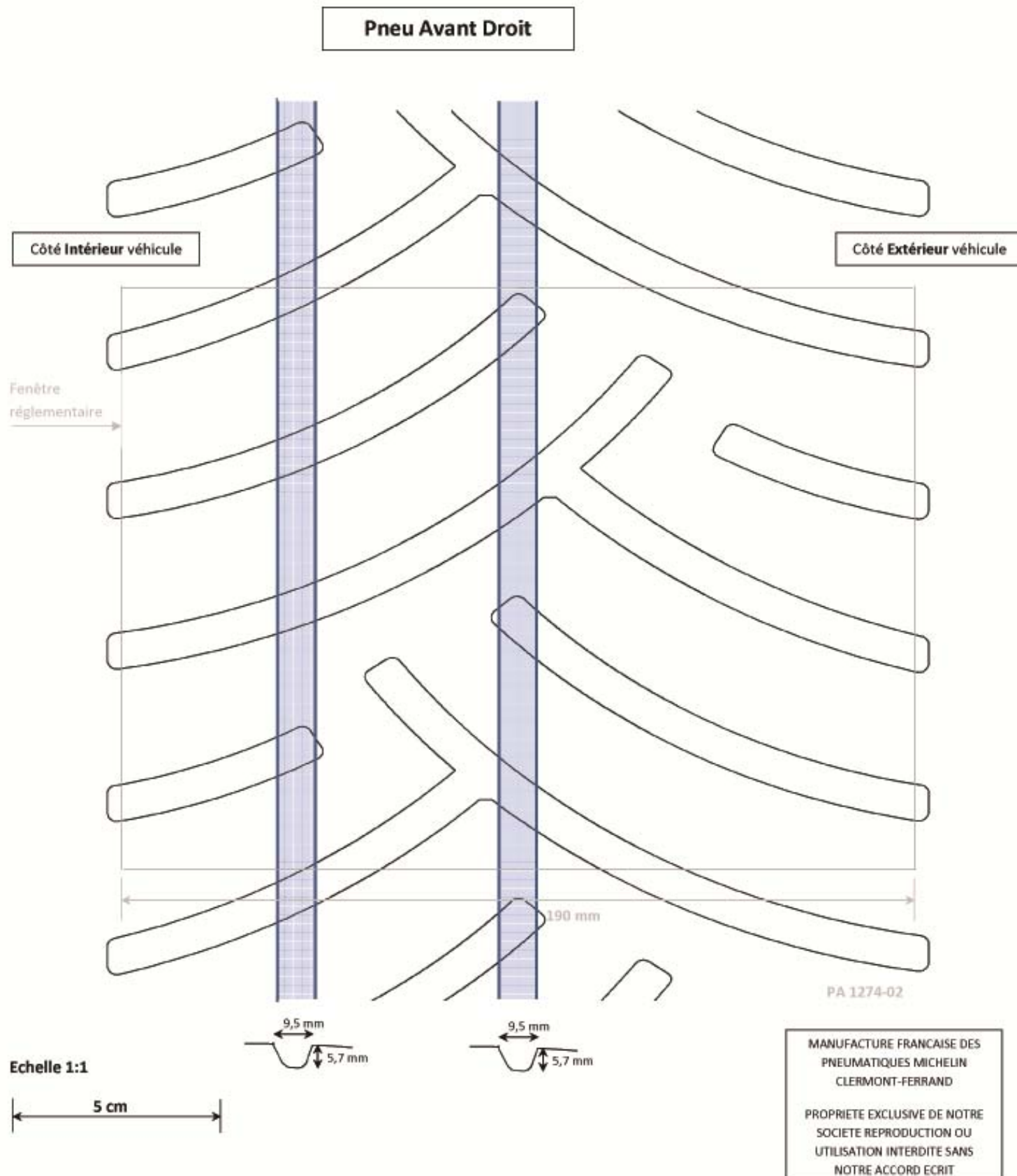

Circonférential groves are hand-cutted.

RGT only – 24/65-18



Domaine : Rallye Asphalte
 Dimension : 24 / 65 - 18
 Entaillement surfacique global : 32,8 %

Clermont-Ferrand le 18/12/2013

Pneu Avant Gauche

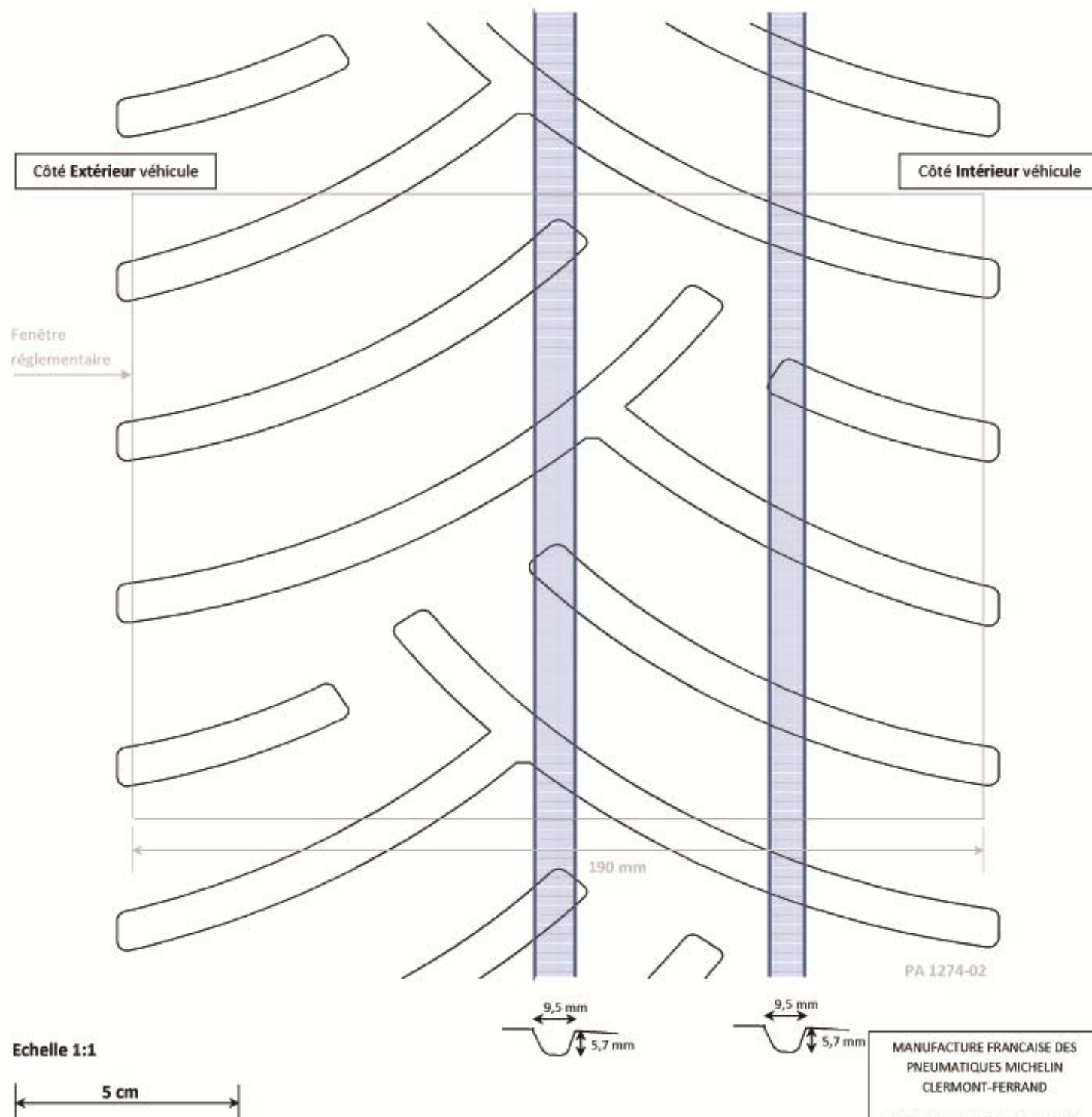

Echelle 1:1



MANUFACTURE FRANCAISE DES
 PNEUMATIQUES MICHELIN
 CLERMONT-FERRAND
 PROPRIETE EXCLUSIVE DE NOTRE
 SOCIETE REPRODUCTION OU
 UTILISATION INTERDITE SANS
 NOTRE ACCORD ECRIT

RGT only – 29/65-18



Domaine : Rallye Asphalte
 Dimension : 29 / 65 - 18
 Entaillement surfacique sur fenêtre de 249 mm de large : 31 %

Clermont-Ferrand le 18/12/2013

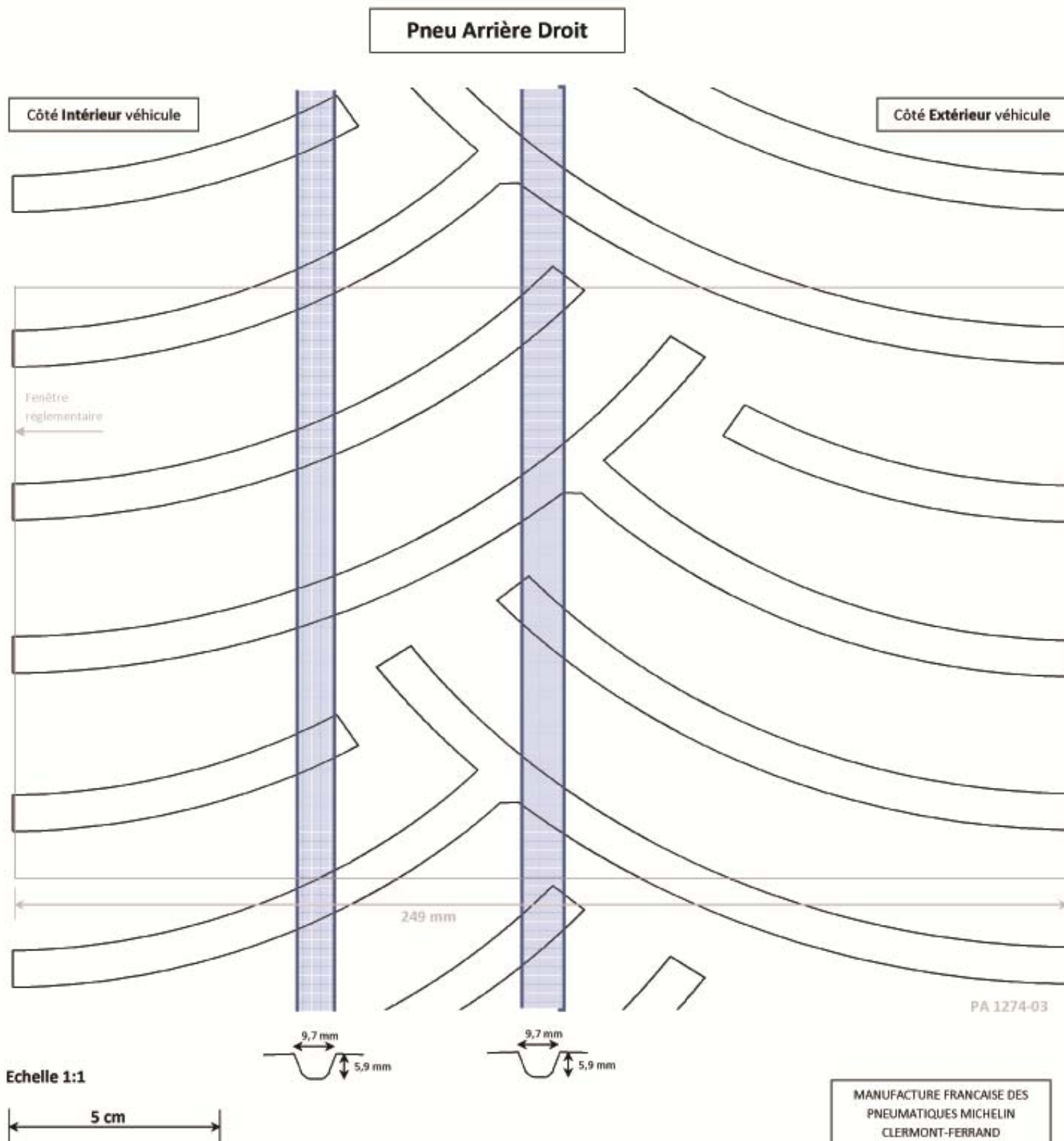

MANUFACTURE FRANCAISE DES
 PNEUMATIQUES MICHELIN
 CLERMONT-FERRAND
 PROPRIETE EXCLUSIVE DE NOTRE
 SOCIETE REPRODUCTION OU
 UTILISATION INTERDITE SANS
 NOTRE ACCORD ECRIT

Circumferential grooves are hand-cutted.

RGT only – 29/65-18



Domaine : Rallye Asphalte
 Dimension : 29 / 65 – 18
 Entaillement surfacique sur fenêtre de 249 mm de large : 31 %

Clermont-Ferrand le 18/12/2013

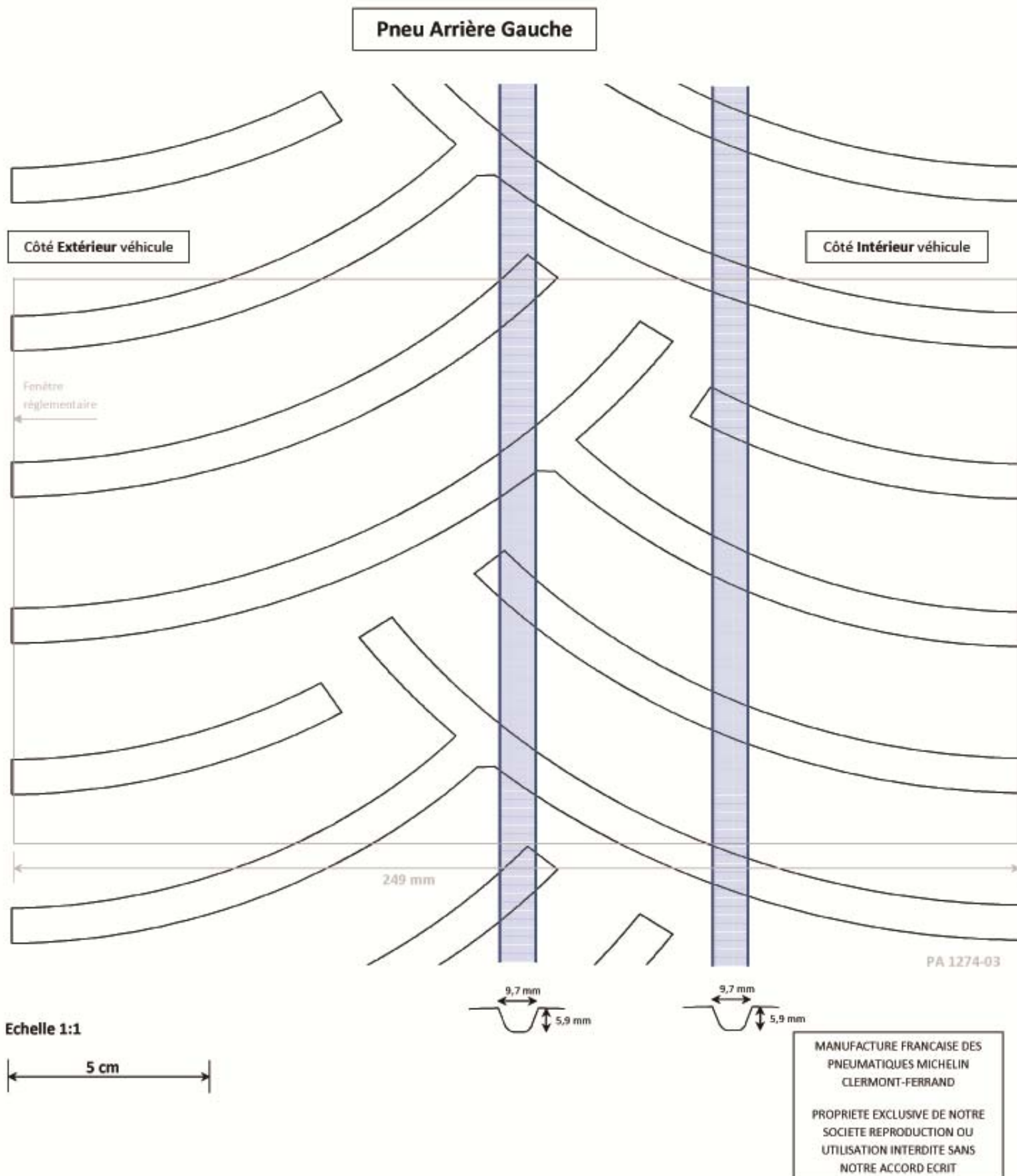

18" – 225/40-18

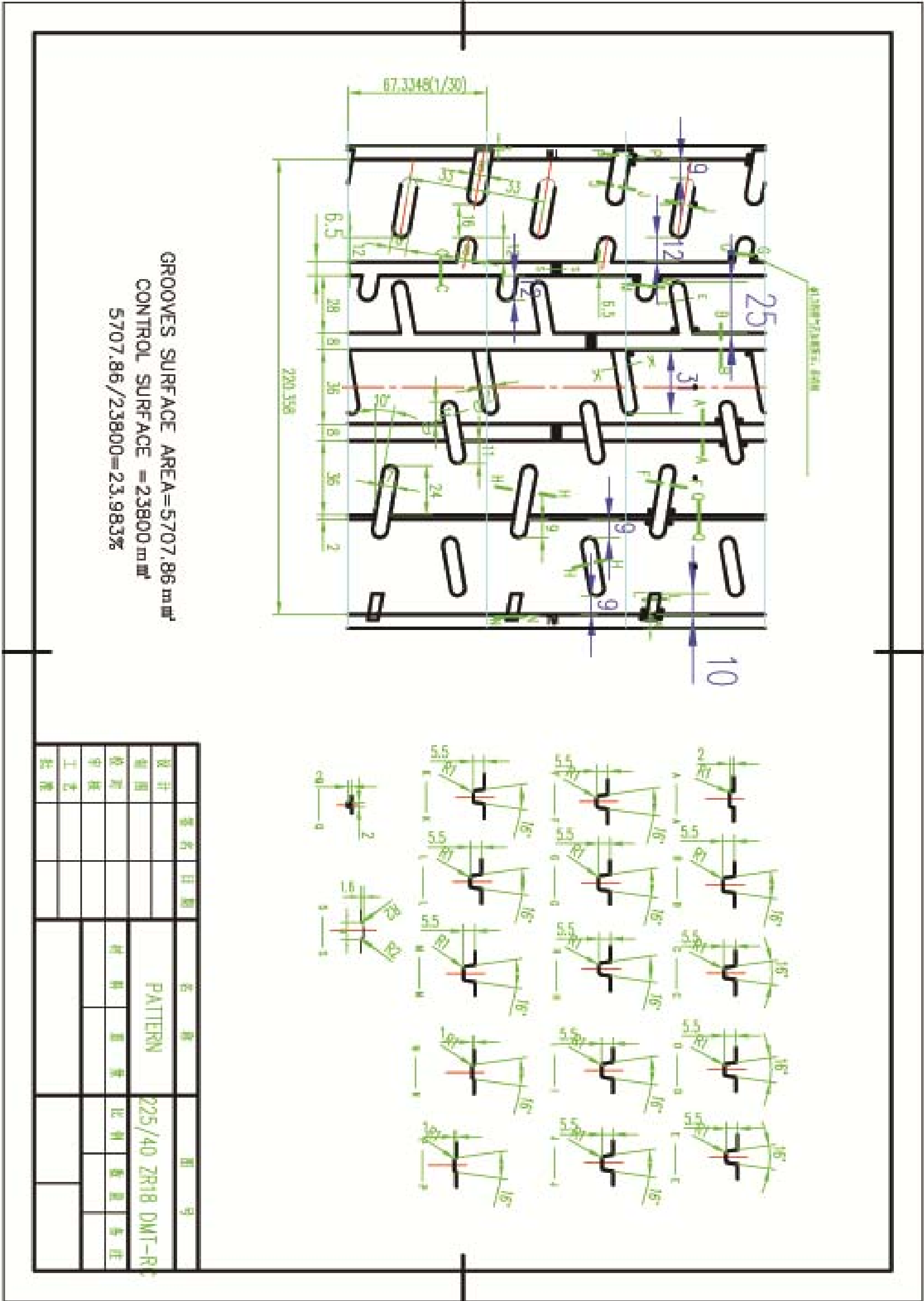

17" - 225/45-17

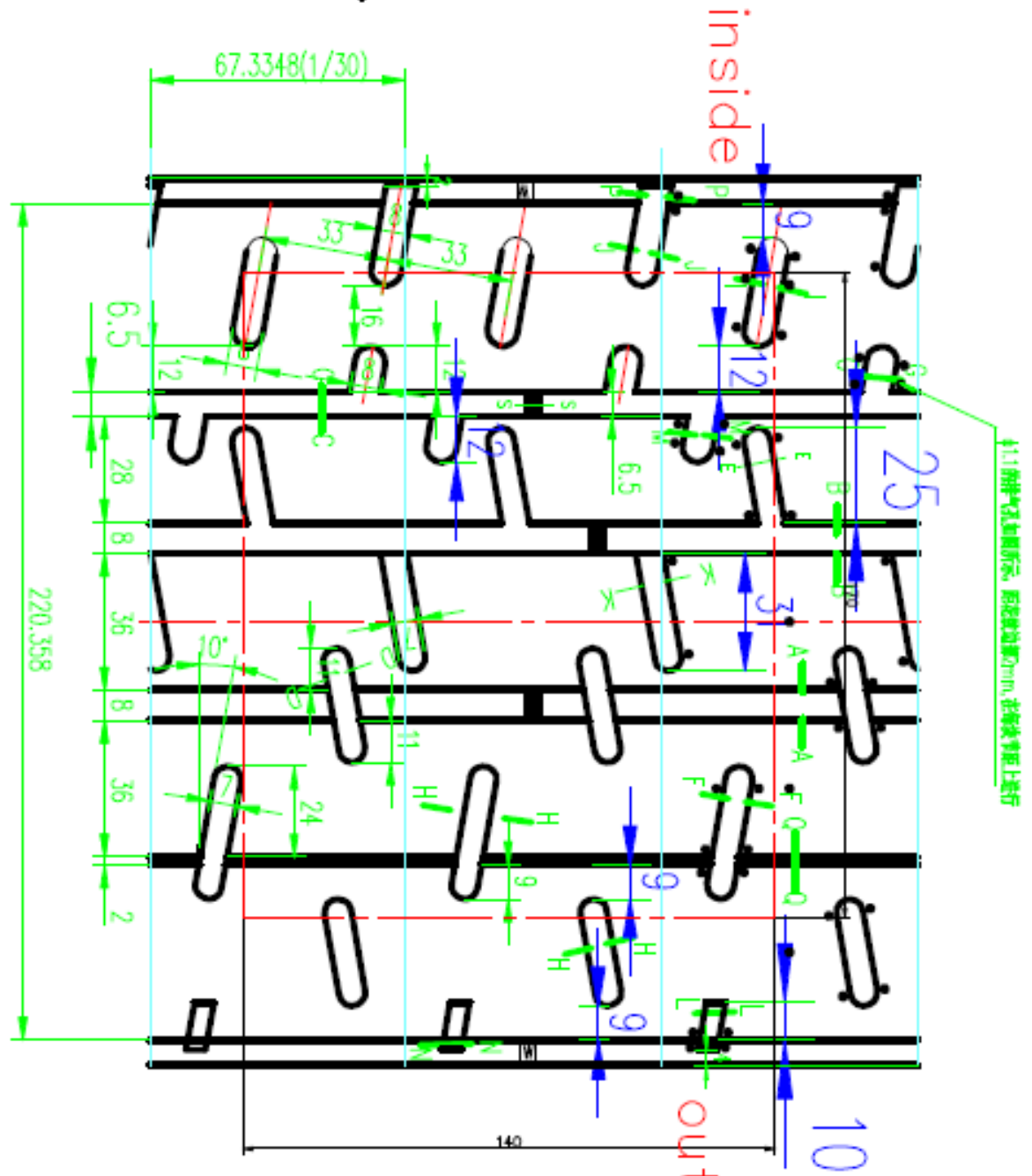

GROOVES SURFACE AREA=5707.86 m²
 CONTROL SURFACE =23800 m²
 5707.86/23800=23.983%

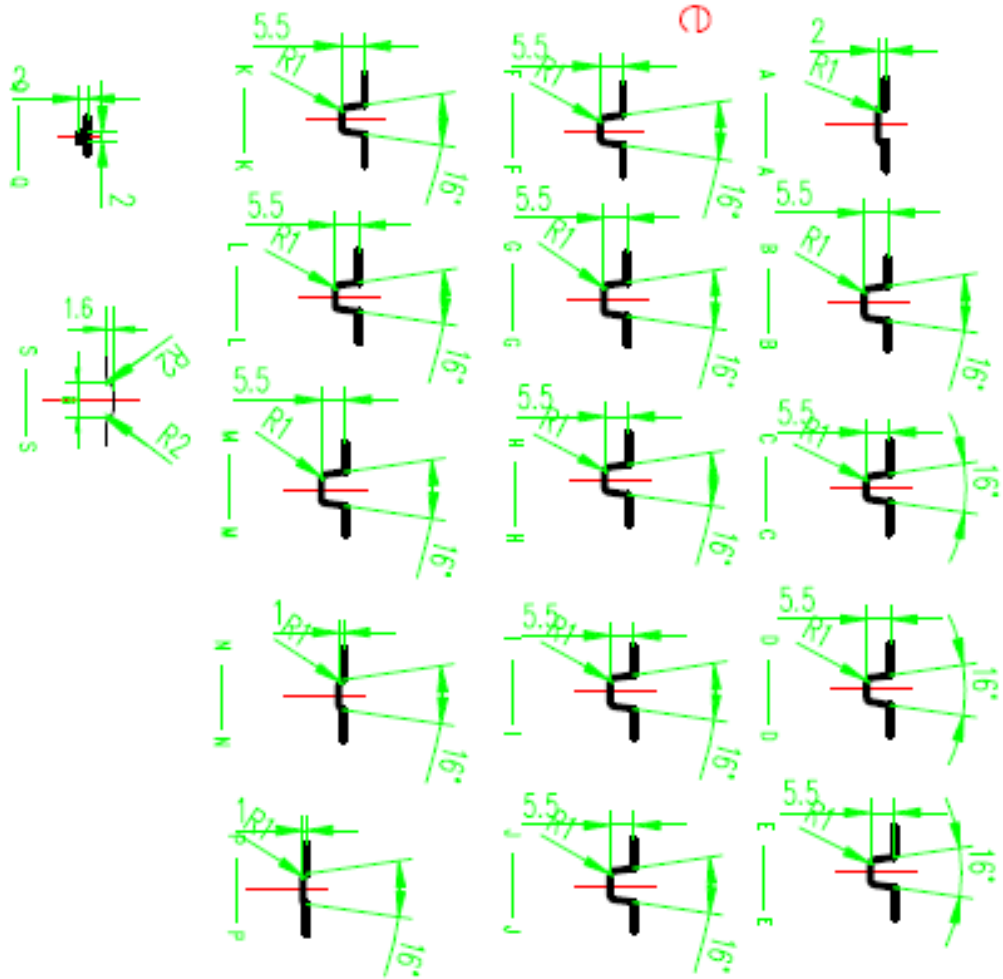

设计	日期	名称	图号
制图		PATTERN	225/45R17 DMT-RC
校对		材料	重量
审核		比例	数量
工艺			备注
批准		Dmack Tyre Ltd	

17" – 195/50-17

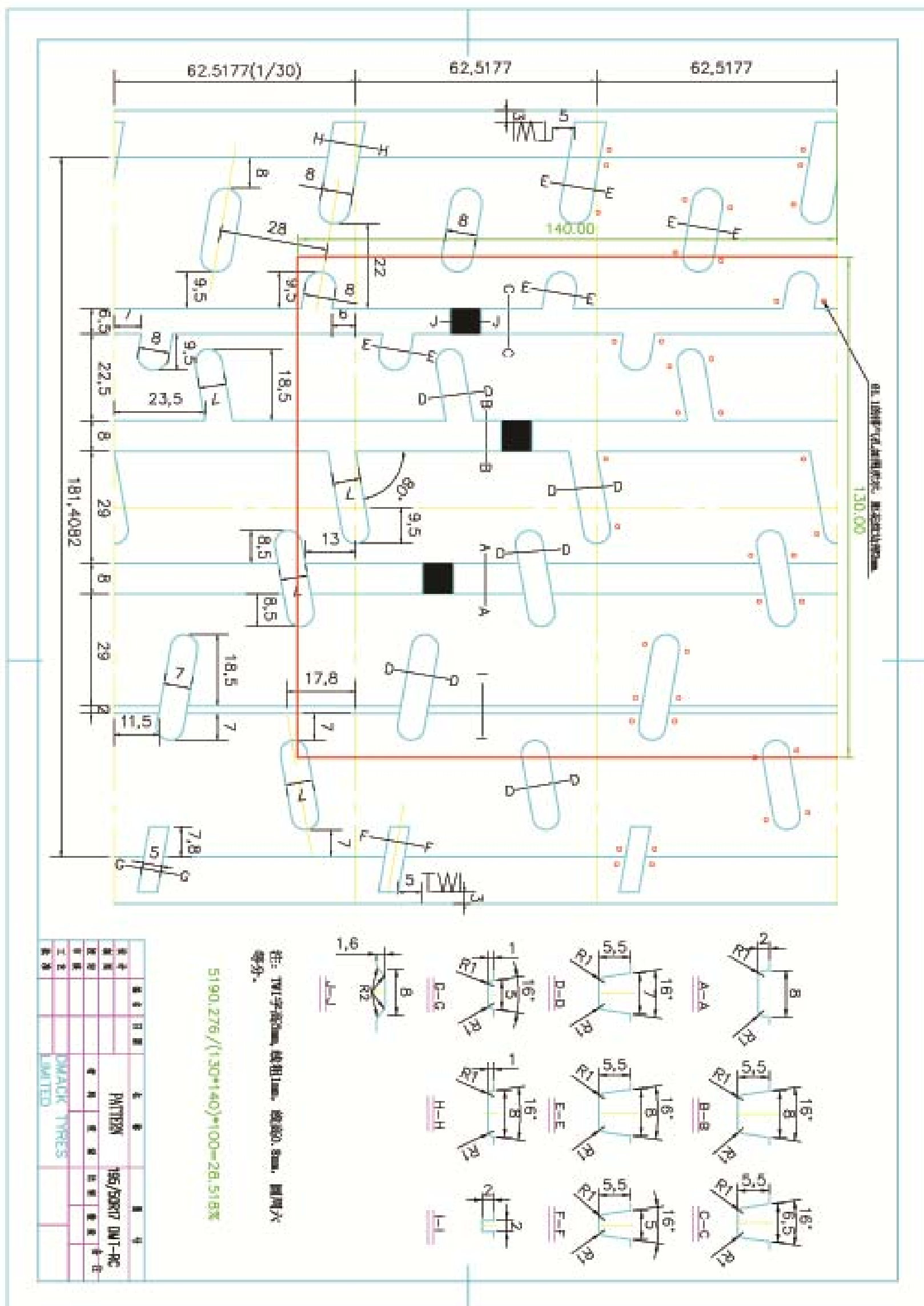

16" – 195/50-16

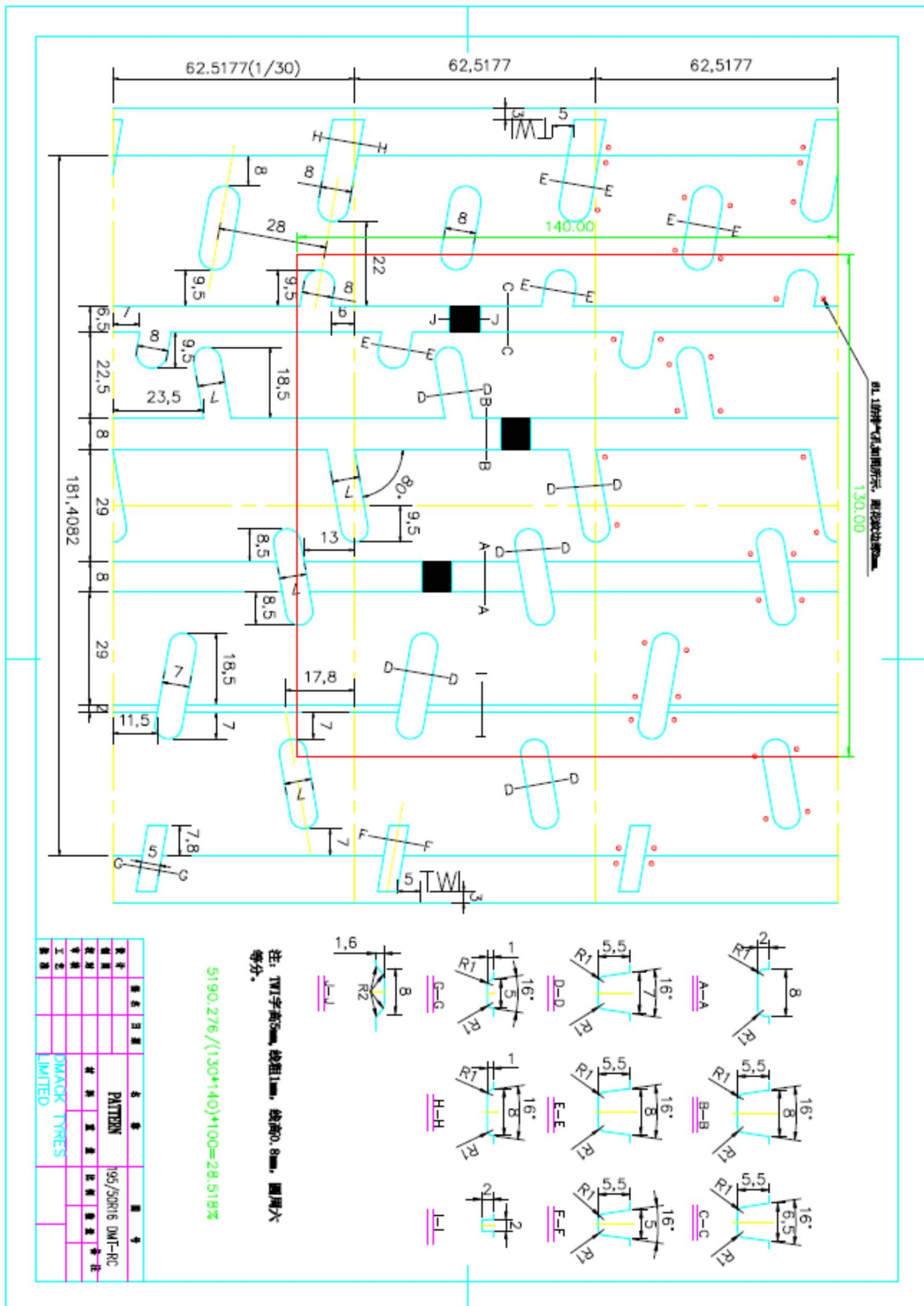

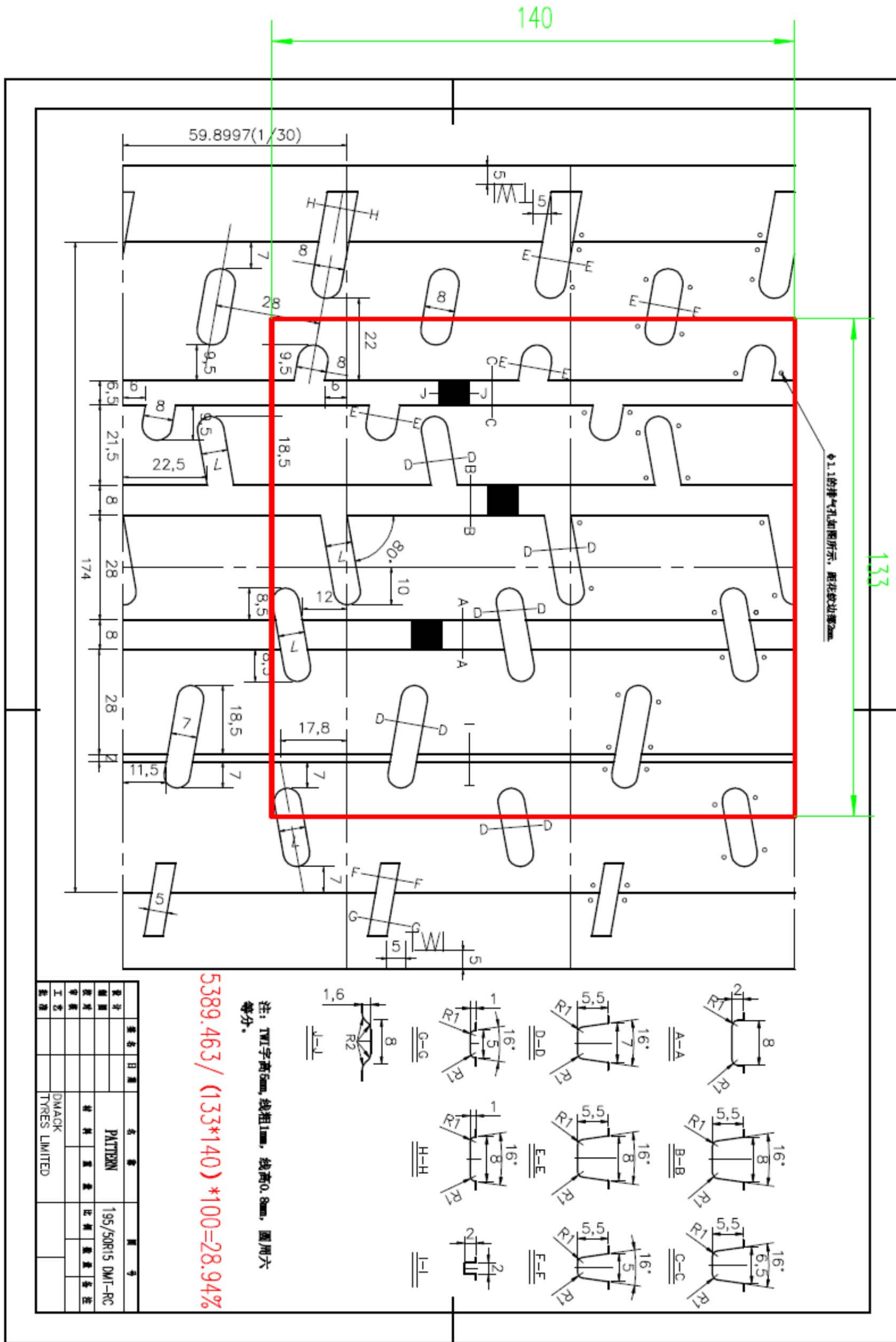

18" – 235/40-18

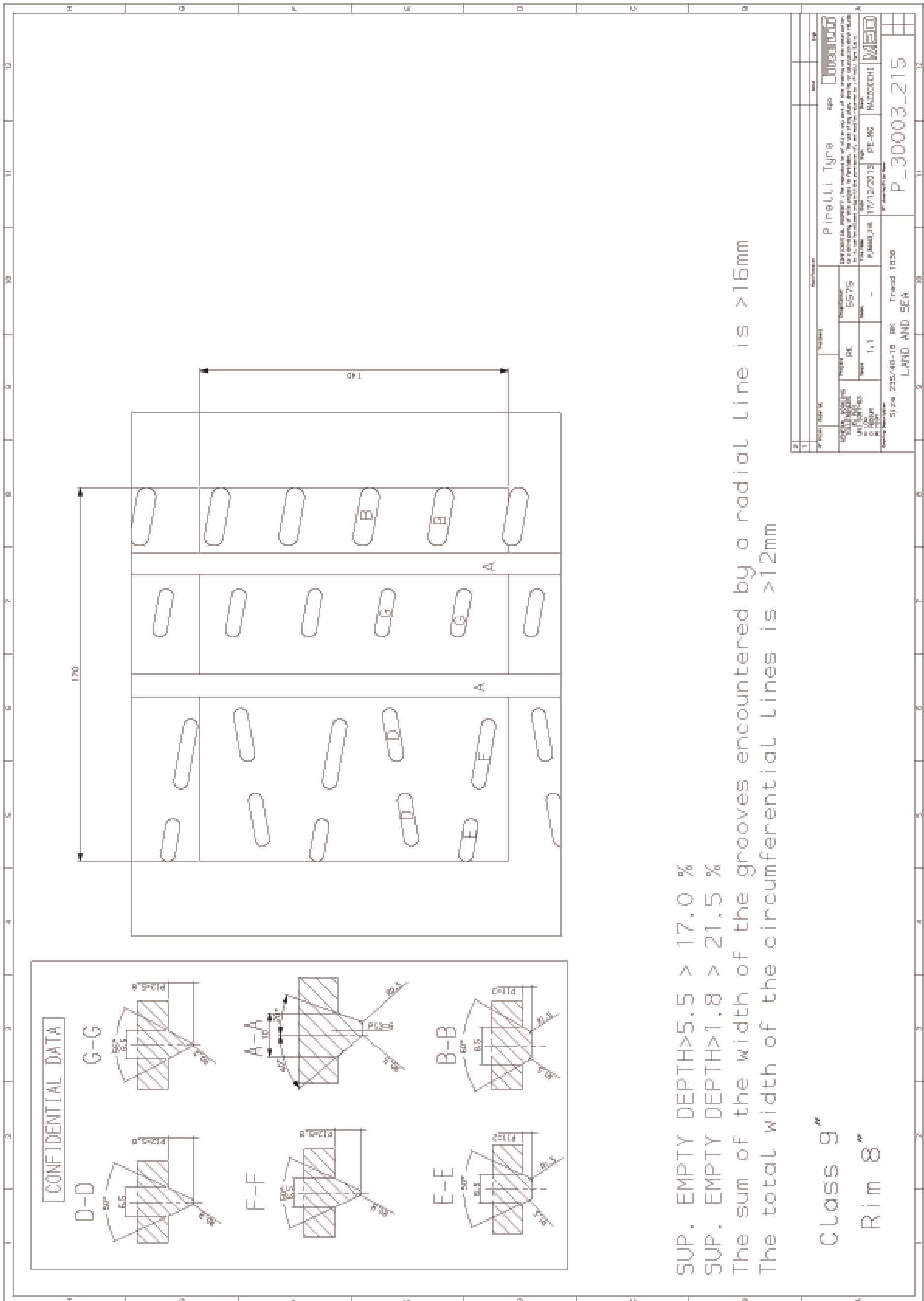

17" - 205/45 - 17

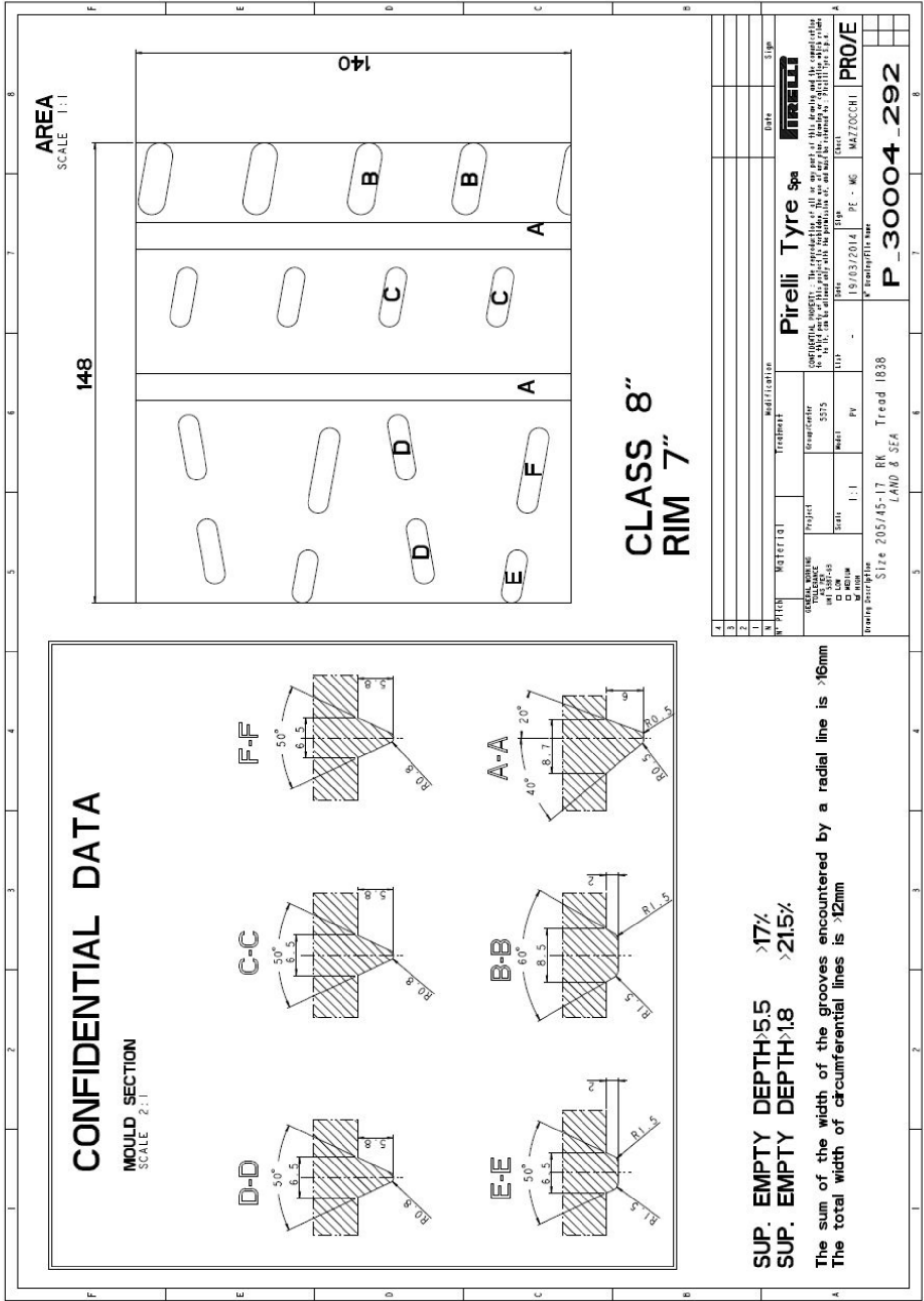

16" - 195/50-16

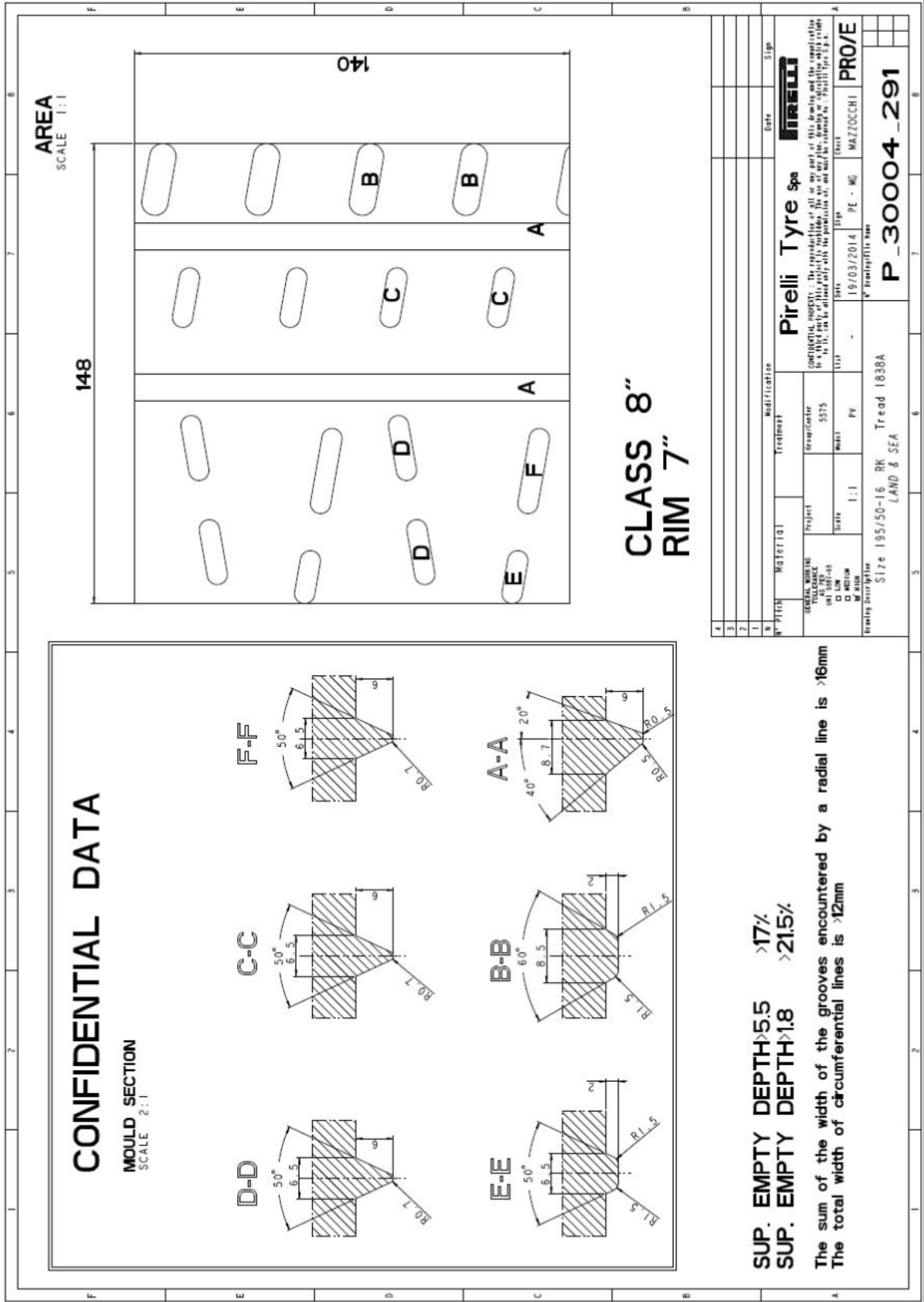

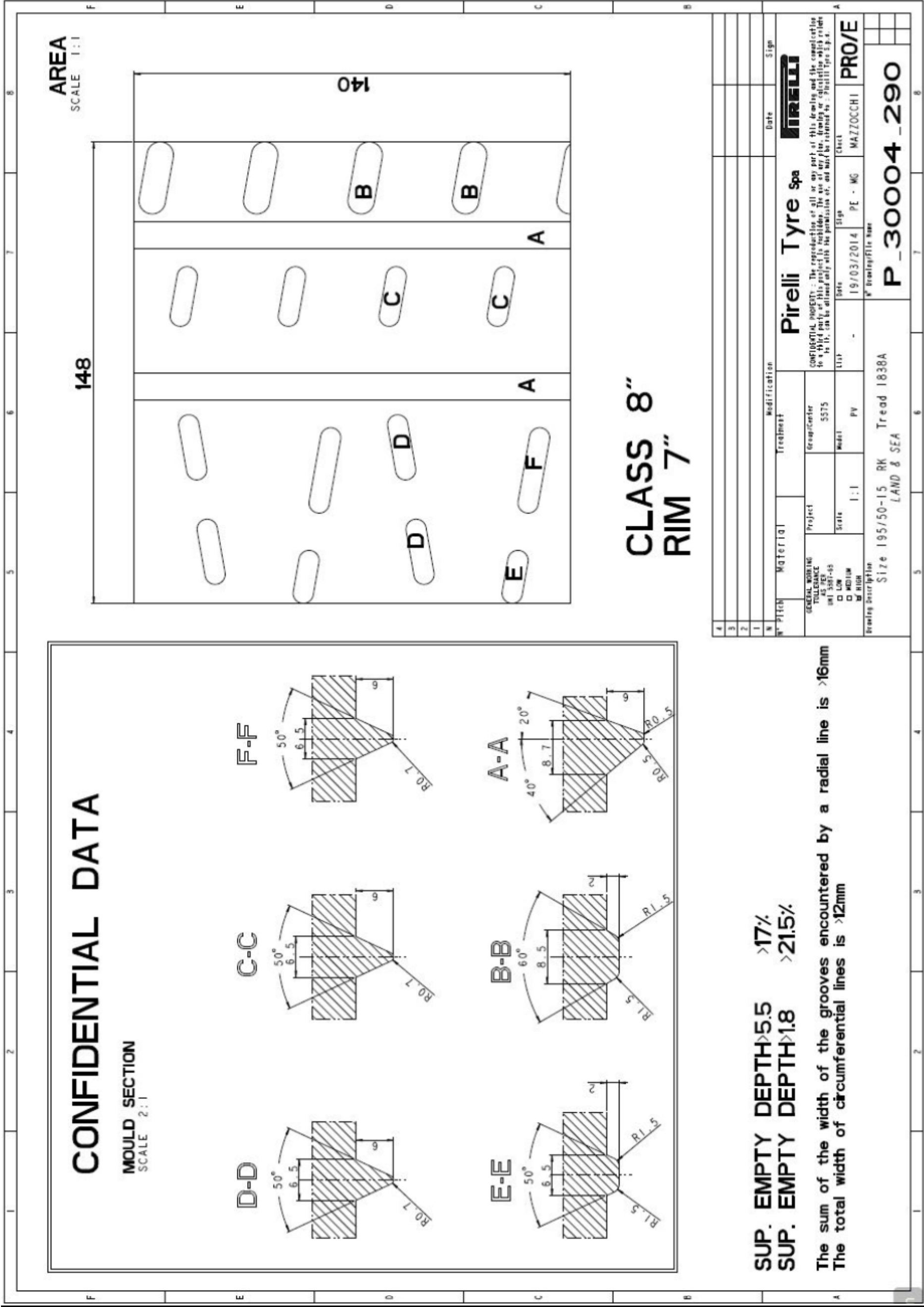

18" – 235/40-18

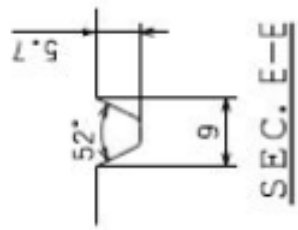
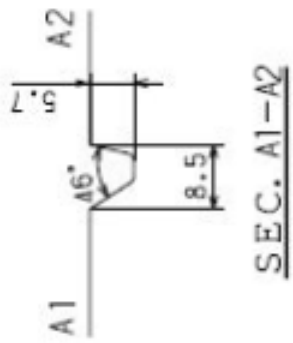
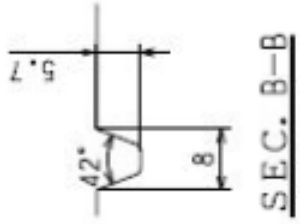
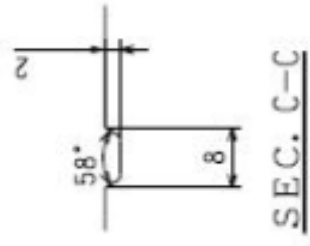

In the control area
 5.5mm grooves-18.1%
 Total grooves-22.2%

----- Control area 170X140

Tyre weight 9.7kg

**PRODUCT NAME
 YOKOHAMA ADVAN A051T**

**PATTERN NAME
 A051A**

SIZE 210/650R18

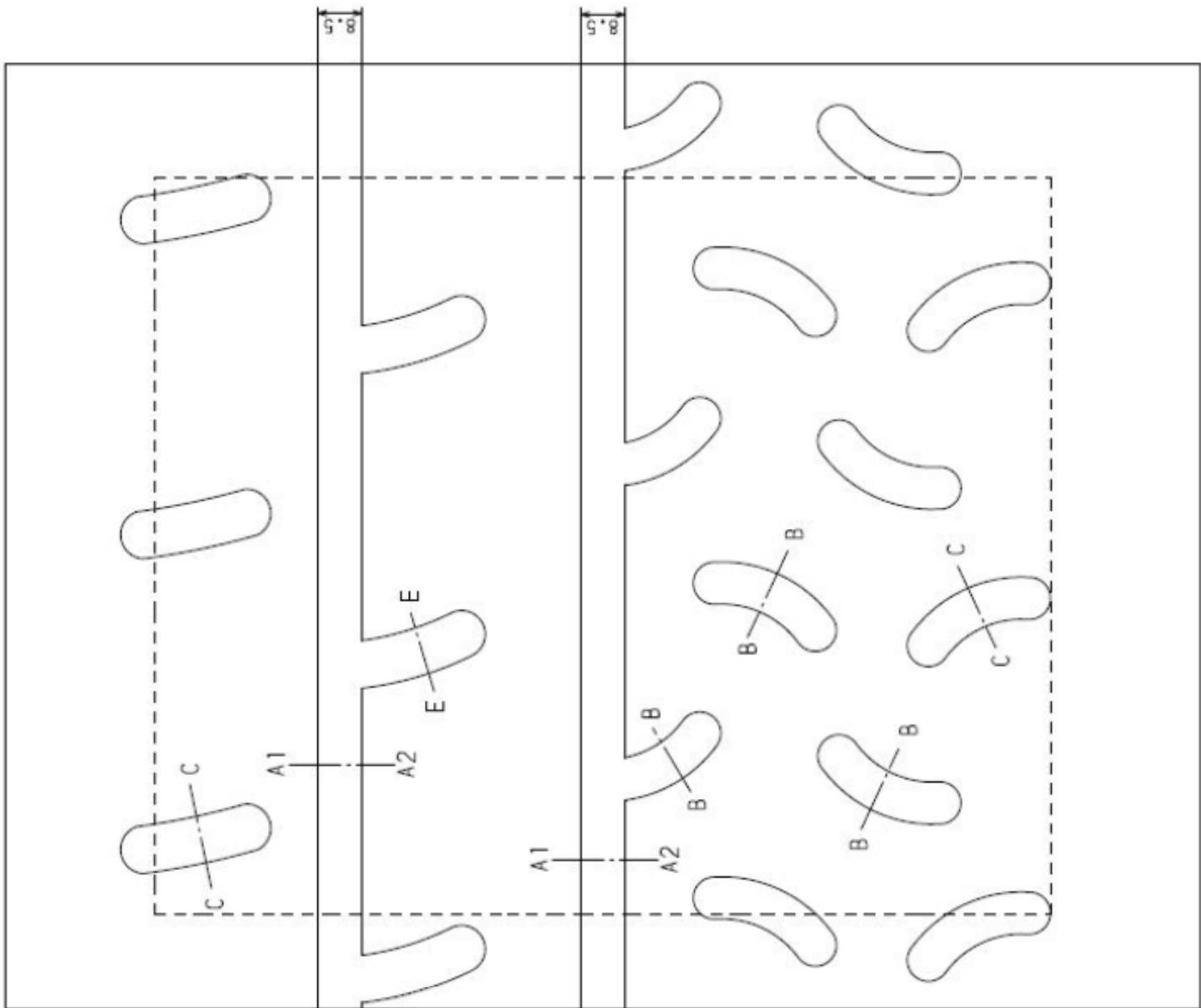

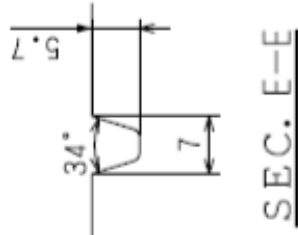
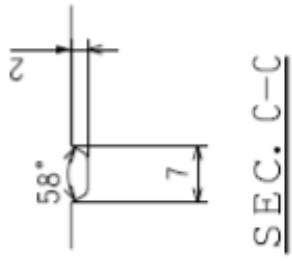
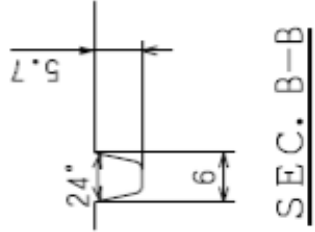
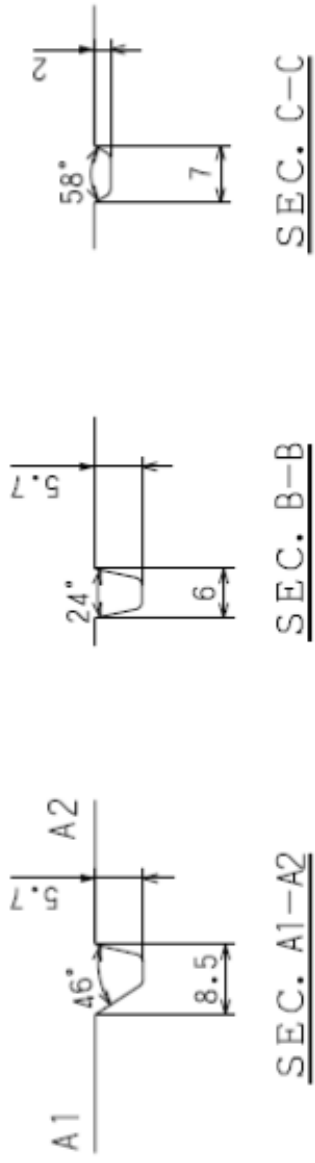
17" – 190/625-17

In the control area
 5.5mm grooves-18.2%
 Total grooves-22.0%

----- Control area 148X140

**PRODUCT NAME
 YOKOHAMA ADVAN A051T**

**PATTERN NAME
 A051A**

SIZE 190/625R17

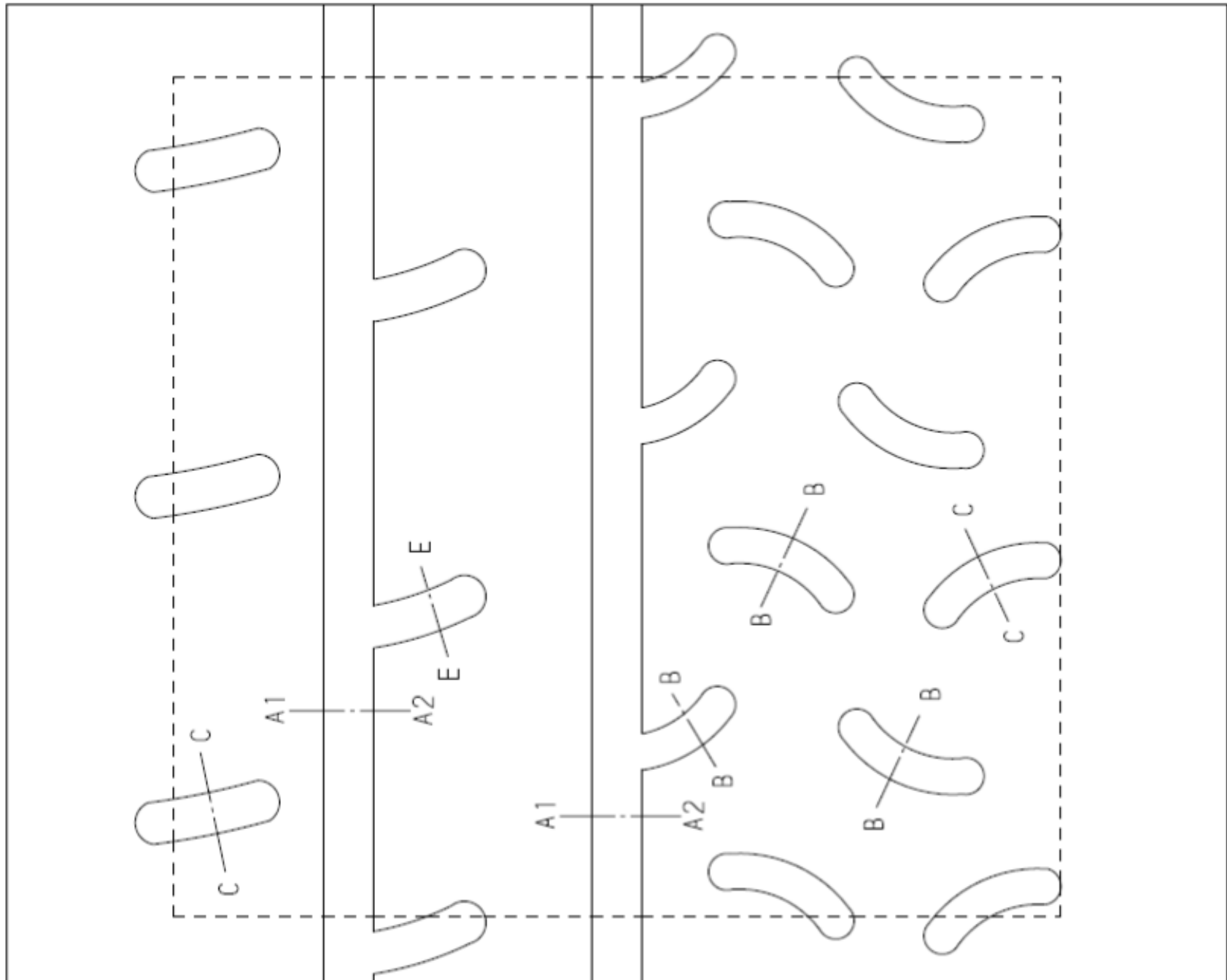

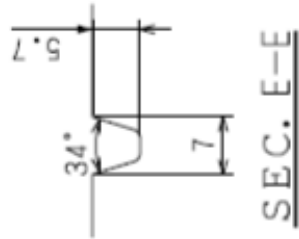
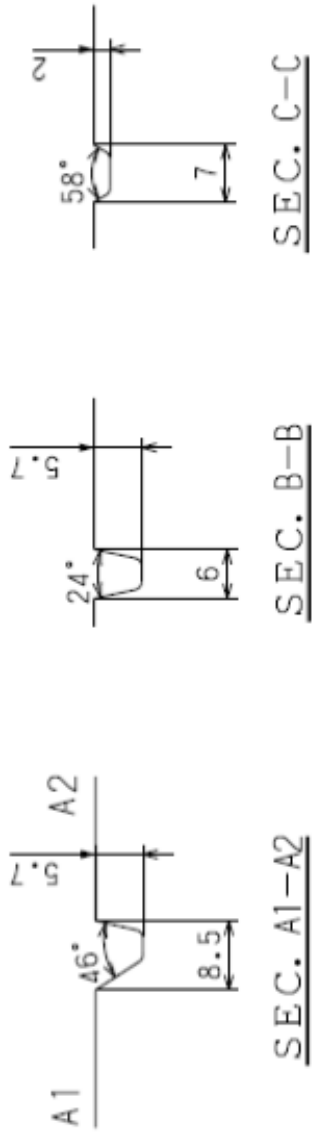

In the control area
 5.5mm grooves-18.1%
 Total grooves-21.9%

----- Control area 148X140

**PRODUCT NAME
 YOKOHAMA ADVAN A051T**

**PATTERN NAME
 A051A**

SIZE 190/600R16

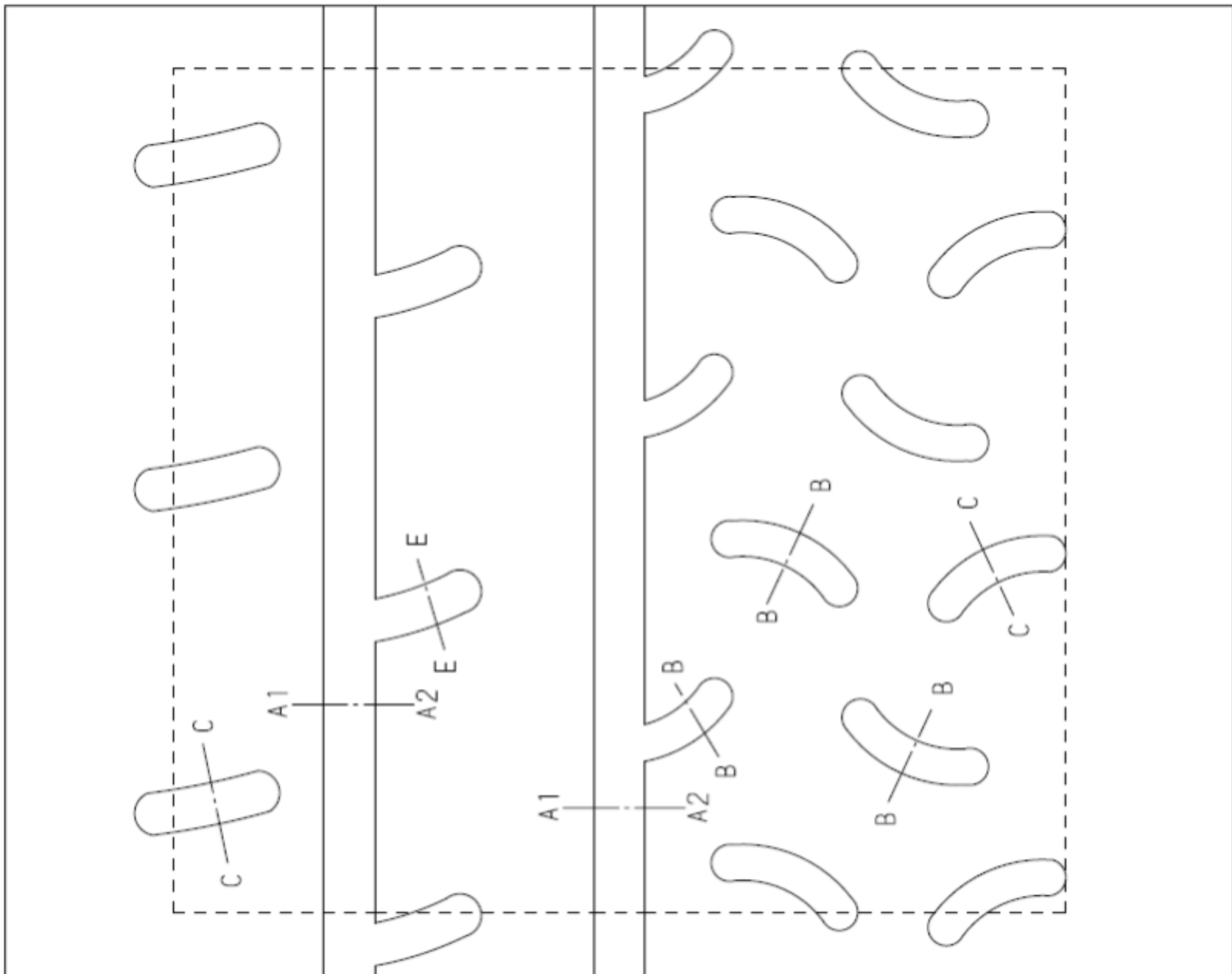

18" - 210/650R18

Product : Ventus Z205

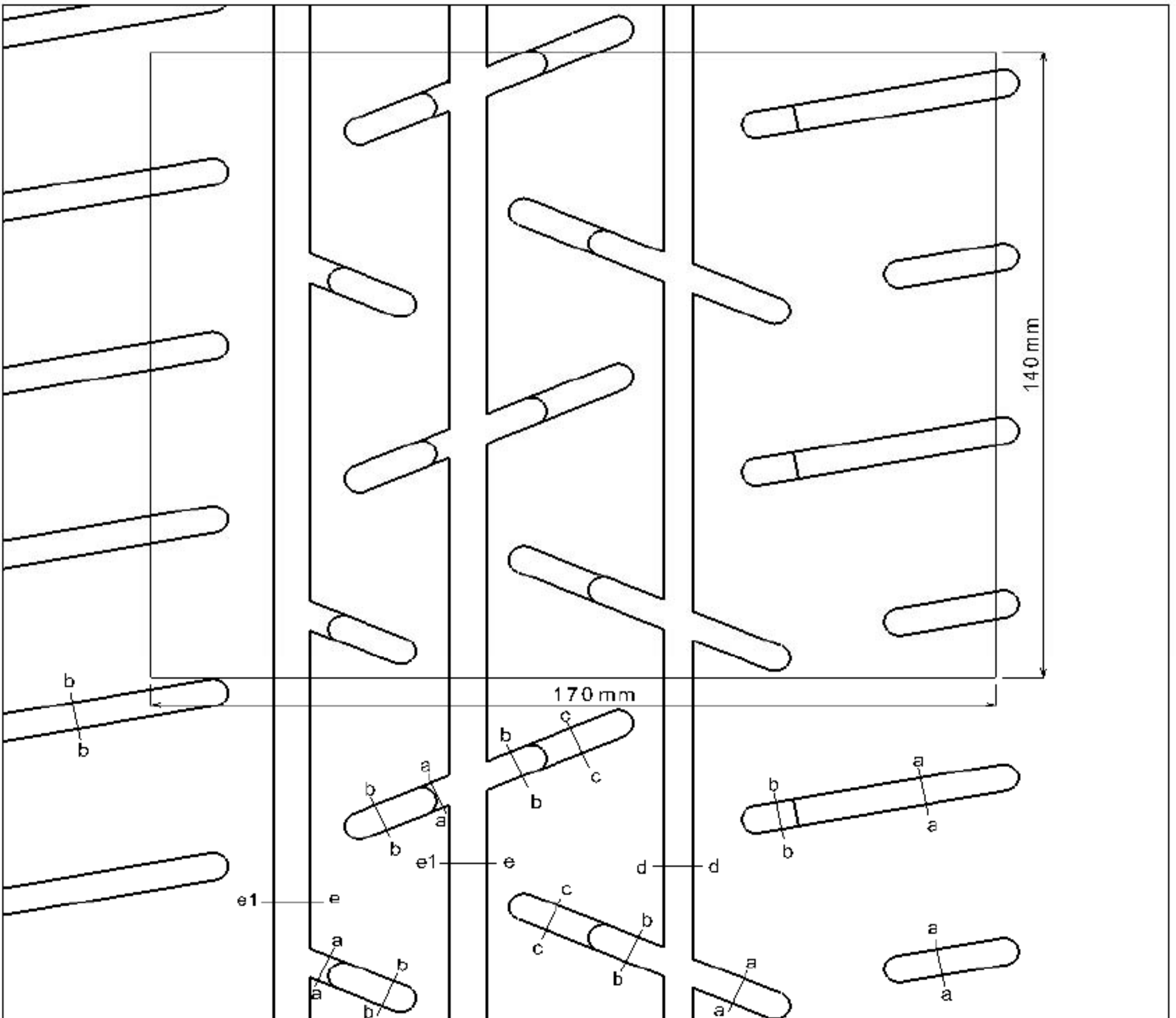

Sec. a-a	Sec. b-b	Sec. c-c
Sec. d-d	Sec. e-e1	

Class 9" (Rim 8")

Empty Depth > 5.5mm : 17.07%

Empty Depth > 1.8mm : 23.30%

GROOVE SURFACE AREA = 554540 mm²

Control Surface = 23800 mm²

17" - 180/625R17

Product : Ventus Z205

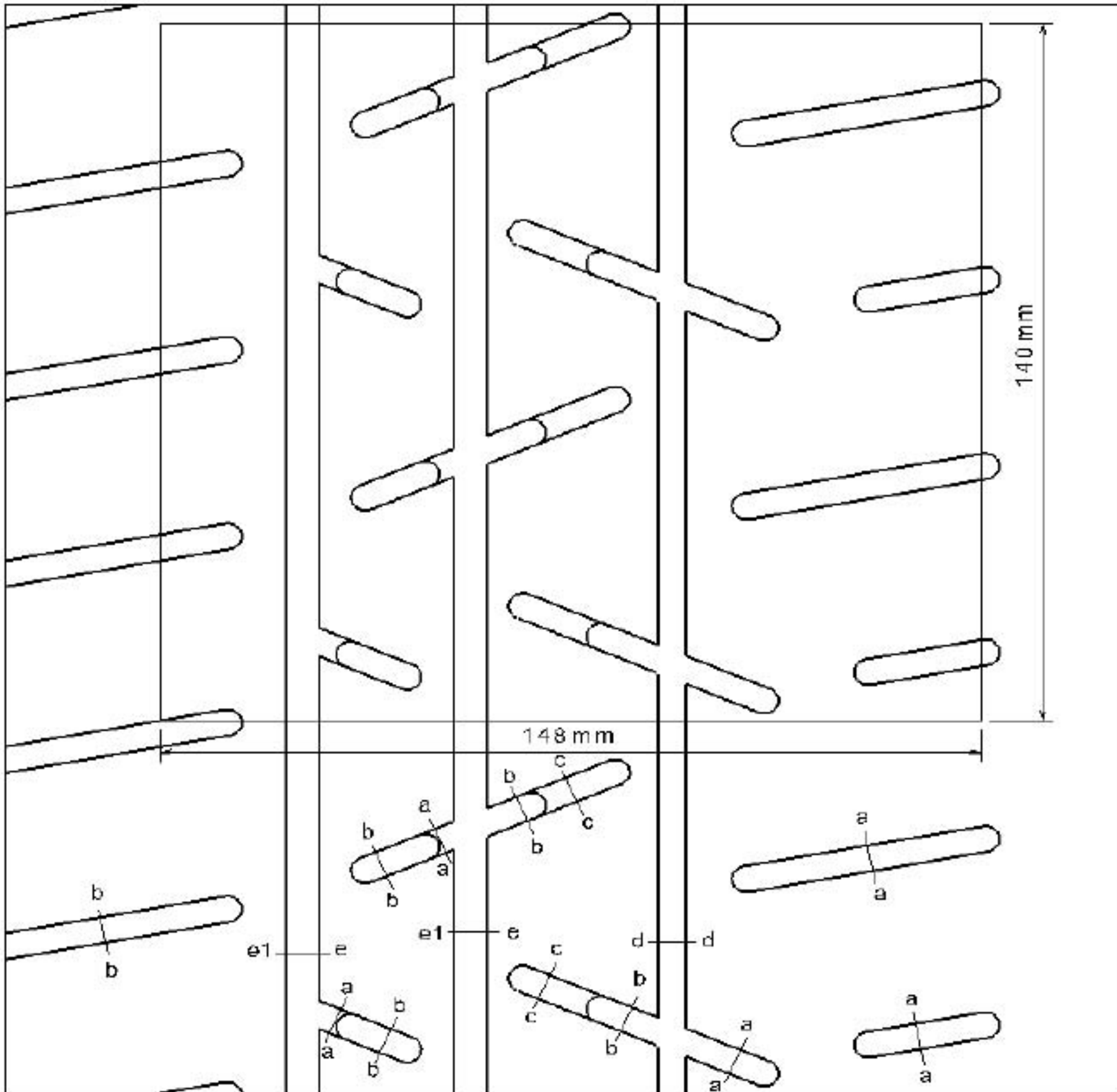

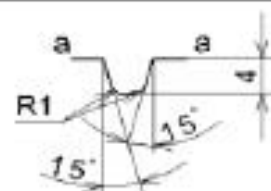
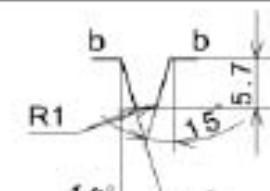
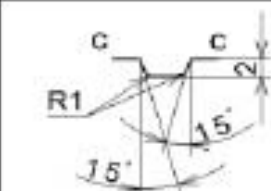
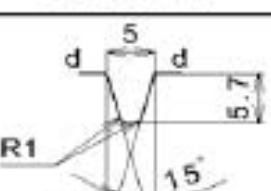
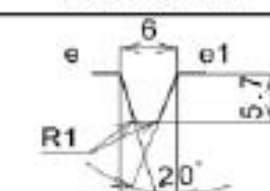
Sec. a-a	Sec. b-b	Sec. c-c
		
Sec. d-d	Sec. e-e1	
		

Class 8" (Rim 7")

Empty Depth > 5.5mm : 17.06%

Empty Depth > 1.8mm : 22.48%

8

GROOVE SURFACE AREA = 353483.2 mm²

Control Surface = 20720 mm²

16" - 180/600R16

Product : Ventus Z205

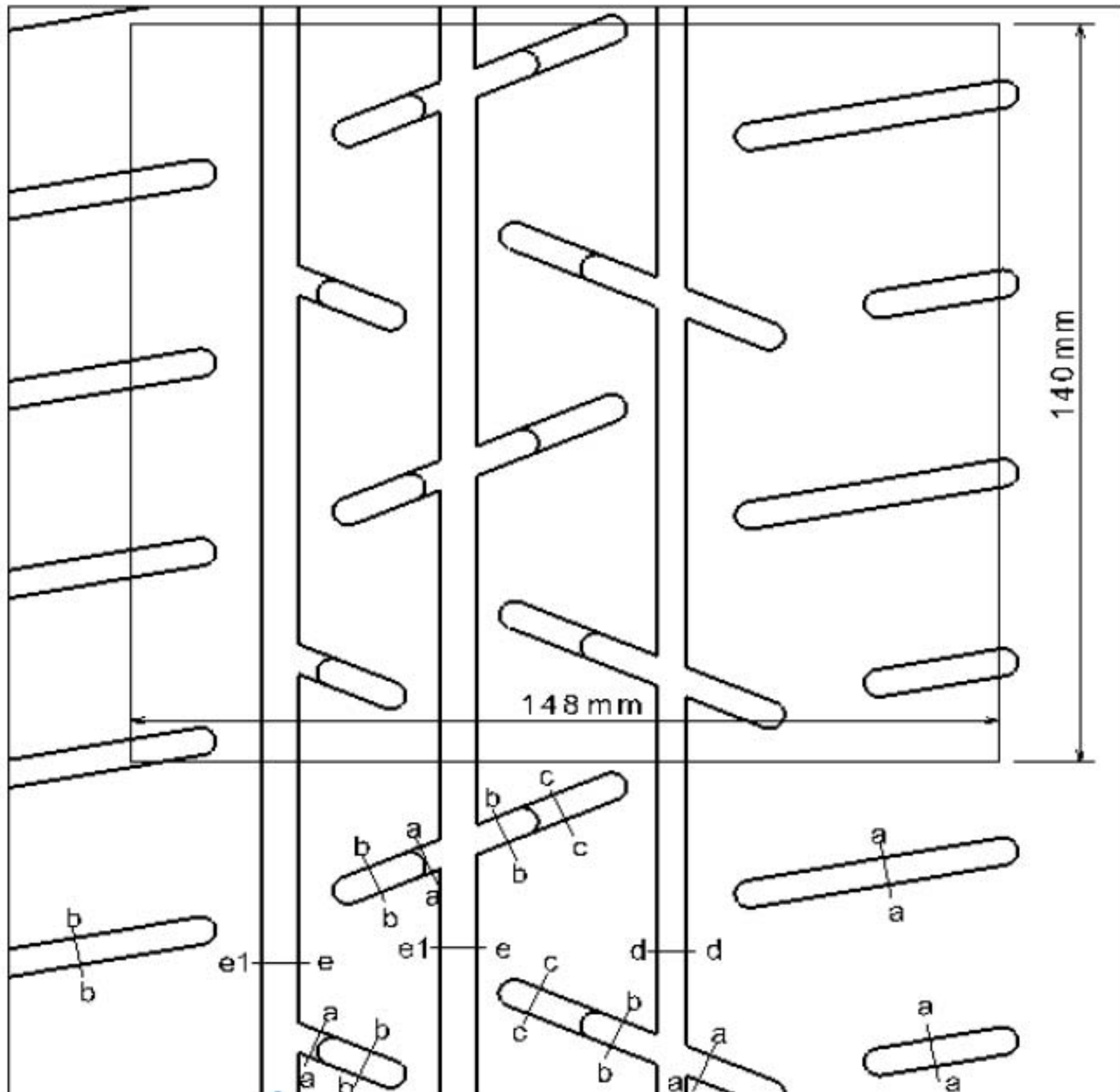

Sec. a-a	Sec. b-b	Sec. c-c
Sec. d-d	Sec. e-e1	

Class 8" (Rim 6.5")

Empty Depth > 5.5mm : 17.30%

Empty Depth > 1.8mm : 22.95%

GROOVE SURFACE AREA = 358456 mm²

Control Surface = 20720 mm²

18" - 210/645R18

KUMHO TYRES



Moulded tyre for FIA homologation
 Size : 210/645R18
 Pattern : TM01

- On the basis of a tread pattern width of 170mm and circumference of 140mm
- * The surface taken up by grooves at least 5.5 mm deep, with a maximum angle of 60° between the block in section and 2mm wide, must occupy at least 17% of the total surface.
 - * The surface taken up by grooves at least 1.8 mm deep, with a maximum angle of 60° between the block in section and 2mm wide, must occupy at least 21.5% of the total surface.
 - * The sum of the width of the grooves encountered by a radial line must be at least 16mm
 - * At least 2 circumferential lines / Minimum total width of circumferential lines at least 12mm

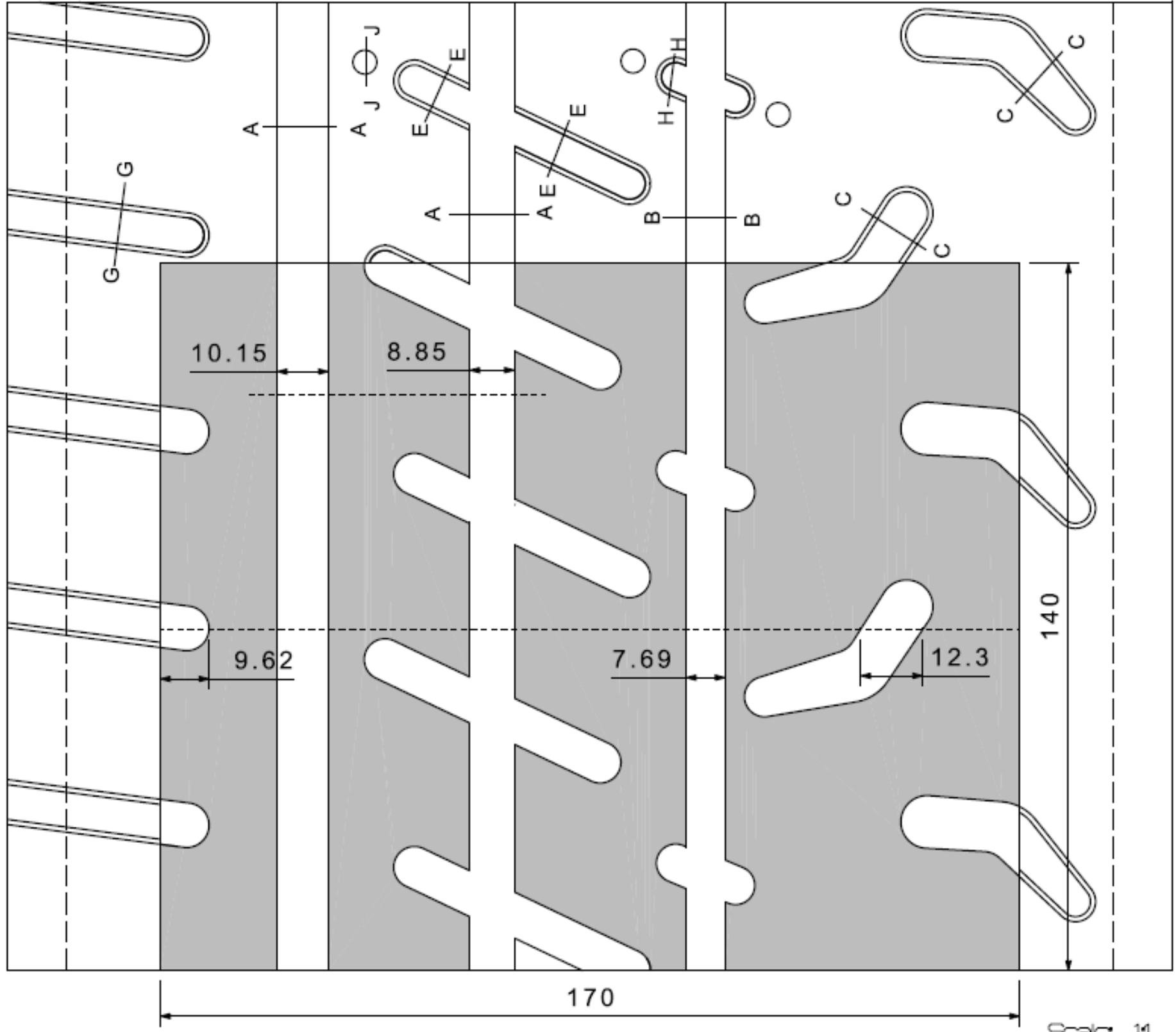

Groove Area by 170 x 140 at least 1.8mm deep : 5815.4mm²
 Void % : 24.4%
 Groove Area by 170 x 140 at least 5.5mm deep : 4580.7mm²
 Void % : 19.2%

